



# DATASHEET RFVSG(-X) Specification V1.26

Single- and Multi-Channel Ultra-Agile Vector Signal Generators

Models up to 4, 6, 12, 20, and 40 GHz



**Document size:**

1 title page  
29 content pages

## DEFINITIONS

- The specifications in the following pages describe the warranted performance of the instrument for  $23 \pm 5$  °C after a 30-minute warm-up period.

**Typical:** Expected mean values, not warranted performance

**Min and max:** Parameter range that is guaranteed by product design, and/or production tested. Warranted performance specifications include guard-bands to account for the expected statistical performance distribution, measurement uncertainties, and changes in performance due to environmental conditions.

## INTRODUCTION

### • Ultra-Agile Vector Signal Generator

The RFVSG is an ultra-fast-switching vector-modulated signal generator series covering a continuous frequency ranges from 10 MHz to 4, 6, 12, 20, or 40 GHz, respectively, with 0.001 Hz resolution, and 400 MHz RF modulation bandwidth.

The RFVSG-X is the corresponding multi-channel product series.

A high performance internal I/Q modulator enables customized waveforms as modulation signals and supports variety of modulation schemes including avionics modulation. The internal dual channel arbitrary waveform generator fitted ensures carrier suppression of >80 dB and image suppression of >75 dB.

The standard RFVSG enables ultra-fast CW frequency sweeping, chirping, intra-pulse modulation, pulse shaping with very low phase noise.

Among others, the following use cases are supported:

- Upload multiple formats of IQ Data into RFVSG Memory. An RFVSG GUI supports data formats from various vendors. The internal RAM can store up to 512 MS (32 bits per I/Q sample) of IQ data. The RFVSG internal AWG can play selected sections of the RAM upon a user trigger.
- Use RFVSG to synthesize and play predefined digital modulation formats (option IVM)
- Use the analog I & Q inputs (option AIQ) with up to 50 MHz analog bandwidth.
- Use FCP interface (option FCP) to:
  - live stream digital IQ data.
  - instantaneously switch between pre-loaded IQ data segments.
  - control for ultra-fast frequency hopping (additionally, option UFS required).

All RFVSGs operate with an ultra-stable temperature compensated frequency reference (OCXO) that can be phase-locked to an external reference.

The compact unit allows for full front panel control via touch panel display, and PC GUI Software supported operation via ETHERNET, USB, FCP and GPIB communication ports.

# FACTS & FIGURES & SPECIFICATIONS

## Signal Specifications

PARAMETER	MIN	TYPICAL	MAX	NOTE
Frequency Range	10 MHz		4 GHz 6 GHz 12 GHz 20 GHz 40 GHz	RFVSG04 RFVSG06 RFVSG12 RFVSG20 RFVSG40
Frequency Resolution		0.001 Hz		
Phase Resolution		0.01 deg		
Frequency & Amplitude Switching / Settling Time		1.5 ms 500 $\mu$ s <100 ns 800 ns		valid signal after SCPI received List sweep within 400 MHz BW, Option UFS within entire frequency range, Option UFS
<b>Output Power Level</b>				See Figures
10 to 100 MHz	-65 dBm		+13 dBm	
0.1 to 4 GHz			+17 dBm	RFVSG04
0.1 to 6 GHz	-60 dBm		+15 dBm	RFVSG06
0.1 to 12 GHz	-60 dBm		+15 dBm	RFVSG12
0.1 to 5 GHz	-60 dBm		+18 dBm	RFVSG20
5 to 10 GHz			+20 dBm	
10 to 20 GHz			+14 dBm	
0.1 to 5 GHz	-60 dBm		+18 dBm	RFVSG40
5 to 10 GHz			+20 dBm	
10 to 20 GHz			+14 dBm	
20 to 30 GHz			+10 dBm	
30 to 36 GHz			+10 dBm	
36 to 40 GHz			+6 dBm	
Power Resolution		0.01 dB		
<b>Power Level Uncertainty</b>				See Figure 5
<4 GHz		0.25 dB	0.7 dB	Digital ALC on, >-20dBm
4 to 6 GHz		0.3 dB	1.0 dB	
6 to 20 GHz		0.3 dB	1.3 dB	
20 to 40 GHz			1.5 dB	
<4 GHz		0.3 dB	0.8 dB	Pmin to -20 dBm
4 to 6 GHz		0.35 dB	1.2 dB	
6 to 20 GHz		0.4 dB	1.3 dB	
20 to 40 GHz			1.5 dB	
<b>Reverse Power Protection</b>				
DC Voltage			$\pm$ 10 V	
RF Power			26 dBm	
<b>Output Impedance</b>		50 $\Omega$		
VSWR		1.8		See Figure
<b>SSB Phase Noise at 1 GHz and 10 dBm</b>				See Figures 1, 2
at 10 Hz from carrier		-87 dBc/Hz -100 dBc/Hz		Option LN
at 1 kHz from carrier		-130 dBc/Hz		
at 20 kHz from carrier		-145 dBc/Hz		
at 100 kHz from carrier		-150 dBc/Hz		
<b>SSB Phase Noise at 4 GHz and 10 dBm</b>				See Figures 1, 2
at 10 Hz from carrier		-74 dBc/Hz -90 dBc/Hz		Option LN
at 1 kHz from carrier		-121 dBc/Hz		
at 20 kHz from carrier		-133 dBc/Hz		
at 100 kHz from carrier		-138 dBc/Hz		

<b>SSB Phase Noise at 10 GHz and 10 dBm</b>				See Figures 1, 2
at 10 Hz from carrier		-70 dBc/Hz -78 dBc/Hz		Option LN
at 1 kHz from carrier		-104 dBc/Hz		
at 20 kHz from carrier		-115 dBc/Hz		
at 10 MHz from carrier		-118 dBc/Hz		
<b>SSB Phase Noise at 20 GHz and 10 dBm</b>				See Figures 1, 2
at 10 Hz from carrier		-63 dBc/Hz -73 dBc/Hz		Option LN
at 1 kHz from carrier		-104 dBc/Hz		
at 20 kHz from carrier		-115 dBc/Hz		
at 10 MHz from carrier		-118 dBc/Hz		
Harmonics @ 0 dBm 0.01 to 4 GHz		-45 dBc	-40 dBc	RFVSG4
Harmonics @ 0 dBm 0.01 to 4 GHz		-45 dBc	-40 dBc	RFVSG6 & RFVSG12
4 to 7 GHz		-35 dBc	-30 dBc	
7 to 12 GHz		-55 dBc	-50 dBc	
Harmonics @ 0 dBm 0.01 to 5 GHz		-50 dBc	-45 dBc	RFVSG20 & RFVSG40
5 to 20 GHz		-35 dBc	-30 dBc	
>20 GHz		-35 dBc	-30 dBc	
Non-Harmonic Spurious (at 0 dBm output, > 10 kHz offset)		-90 dBc -80 dBc -80 dBc -70 dBc -60 dBc -55 dBc	-75 dBc -70 dBc -50 dBc -50 dBc -50 dBc -45 dBc	< 1.2 GHz 1.2 to 2.5 GHz 2.5 to 4 GHz 4 to 12 GHz 12 to 20 GHz > 20 GHz

## I/Q Modulator

PARAMETER	MIN	TYPICAL	MAX	NOTE
RF modulation bandwidth		400 MHz		
IQ Frequency response				Over full IQ bandwidth
< 10 GHz		<±1.0 dB		
10 to 30 GHz		<±2.0 dB		
30 to 40 GHz		<±3.5 dB		
Carrier leakage		-90 dBc	-70 dBc	
Image sideband rejection		-85 dBc	-65 dBc	

## Internal I/Q Baseband Generator

PARAMETER	MIN	TYPICAL	MAX	NOTE
Sample resolution		16 bits		each I and Q
Clock source		Internal		
Sample rate	10 Hz		500 MHz	
Sample rate resolution		1 Hz		
Waveform length	96 Sa 246 Sa		512 MSa 334 MSa	* Marker signals active
External trigger to RF output delay		tbd		500 MHz sample rate
<b>Segment mode</b>				
Number of segments	1		65536	
Segment changeover		Seamless, immediate		
Trigger modes		tbd: Same segment, next segment, addressed segment		
Sequencer play list length	1		2048	
Sequency segment repetitions	1		tbd	
Changeover time		tbd (meas)		500 MHz sample rate, external trigger, immediate segment changeover
<b>Marker signals</b>		Markers are defined during the waveform generation process.		
Number of markers		4		
Type		waveform		
Marker outputs		MF1 Out, MF2 Out		Selectable, see chapter MULTI FUNCTION OUTPUTS
Marker delay setting range		tbd		
Marker delay setting resolution		tbd		
Marker duration minimum value		1 sample 4 samples		Sample rate <= 125 MHz Sample rate > 125 MHz
Marker duration variation			+/- 8 ns +/- 1 sample	
Marker jitter			+/- 8 ns +/- 1 sample	
Marker polarity		Normal / inverted		
Marker output to RF output delay		typ. - 367 ns		

\* Shorter Waveforms will be automatically extended by cyclically repeating the waveform.

## Internal Vector Modulation (Option IVM)

PARAMETER	MIN	TYPICAL	MAX	NOTE
Modulation schemes	8QAM, 16QAM, 32QAM, 64QAM, 128QAM, 256QAM, 512QAM, 1024QAM, 2048QAM, 4096QAM			
Symbol rate	10 S/s		200 MS/s	
Basband Filter	cosine, root cosine, Gaussian, rectangular, Dirac, rectangular asymmetric			
Filter parameter range				
Cosine, root cosine (parameter $\alpha$ )	0.05		1	
Gaussian (parameter B x T)	0.05		2.5	
Data source	PRBS generator, user data list			
Data lists	8 bits		tdb	

## Multicarrier Generation (Option IVM)

PARAMETER	MIN	TYPICAL	MAX	NOTE
Number of carriers	1		1024	
Frequency offset	-200 MHz		200 MHz	
Power offset	-60 dB		0 dB	0.1 dB resolution
Tone initial phase offset	0 deg		360 deg	0.1 deg resolution

## Avionics Modulation (Option AVIO)

PARAMETER	MIN	TYPICAL	MAX	NOTE
<b>AVIO Modulation DME</b>				
Operating modes	interrogation & reply			
DME channel	X, Y			
Frequency range	960 MHz		1215 MHz	
Pulse on/off ratio		80 dB	70 dB	
Pulse rise/fall times	100 ns		50 $\mu$ s	100 ns resolution
Pulse width	100 ns		50 $\mu$ s	100 ns resolution
Pulse spacing	100 ns		300 $\mu$ s	100 ns resolution
Pulse rate	10 Hz		10 kHz	1 Hz resolution
Pulse shaping	cos, cos <sup>2</sup> linear, gauss			individually settable for rising & falling edge
ID code		tdb		
ID rate		tdb		
<b>AVIO Modulation VOR</b>				
Bearing accuracy	$\pm 2\%$ / $\pm 0.5$ deg			
Subcarrier frequency accuracy	9960 $\pm$ 2 Hz			
AM accuracy	30 $\pm$ 1%			
AM distortion (THD)			2%	
FM accuracy	480 $\pm$ 1 Hz			
<b>AVIO Modulation ILS</b>				
AM accuracy	40 $\pm$ 1%			
AM distortion			0.5%	
DDM resolution		0.0002 0.0004		Localizer Glide Slope
DDM accuracy		0.0004 0.0008		Localizer Glide Slope
<b>Marker Beacon</b>				
AM tone accuracy (95% AM)		5% of setting		
AM tone distortion (95% AM)		5%		



## Analog Modulation (Option MOD)

PARAMETER	MIN	TYPICAL	MAX	NOTE
<b>Pulse Modulation</b>				
Modulation source	internal Pulse Generator/ external			
Modulator	RF (internal/external) or Baseband (BB, internal)			
Pulse rise/fall time		5 ns		10% / 90% of amplitude
On/off ratio	40 dB 90 dB 50 dB TBD dB	45 dB 95 dB 50 dB TBD dB		BB pulse modulator <4 GHz RF pulse modulator >4 GHz RF pulse modulator
Pulse overshoot			1 dB	
Video feedthrough		tbd		
Polarity / video polarity	normal / inverted			independently selectable
External pulse input to video output delay		20ns (meas)		
Video output to RF output delay		5ns (meas) 350ns (meas)		RF modulator BB modulator
External trigger to video output delay		TBD		
Pulse jitter (internal source)			<1 ps	
<b>Internal Pulse Generator</b>				
Pulse Mode	single pulse			
Pulse period setting range	16ns		10s	
Pulse period setting resolution		8ns		
Pulse width setting range	0ns		10s	
Pulse width setting resolution		8ns		
Pulse width accuracy		same as time base		
<b>Amplitude Modulation</b>				
Modulation source		Internal / External		External requires option AIQ
Modulation depth	0%		100%	Output is clipped at max power level
Deviation accuracy		0.1%	1%	1 kHz rate, 80% depth
Deviation resolution		0.1%		
Distortion (THD)			1%	1 kHz rate, 80% depth
Modulation frequency range	0.1 Hz		100 MHz	
Modulation waveforms		Sine, Square		
<b>Frequency Modulation</b>				
Modulation source		Internal / External		External requires option AIQ
Maximum frequency deviation (peak)	200 MHz			
Deviation accuracy		0.5%	1%	
Distortion (THD)		< 1%		1 kHz rate, 10 kHz deviation
Modulation frequency range	0.1 Hz		100 MHz	
Modulation waveforms	Sine			
<b>Phase Modulation</b>				
Modulation source		Internal / External		External requires option AIQ
Phase deviation (peak)	0		100 rad	
Deviation accuracy		0.5%	1%	
Modulation frequency range	0.1 Hz		100 MHz	
Modulation waveforms	Sine			
Distortion (THD)		< 1%		1 kHz rate & N x rad deviation

## Frequency Reference

PARAMETER	MIN	TYPICAL	MAX	NOTE
<b>Internal Reference Frequency</b>		100 MHz 10 MHz		Option LN
Initial calibrated accuracy			±10 ppb	At 23 ± 3 °C
Temperature stability			±100 ppb ±20 ppb	0 to 50 °C Option LN
Aging after 1st year			1 ppm 0.03 ppm	Option LN
Aging per day			5 ppb 0.5 ppb	after 30 days operation Option LN
Warm-up time	5 min			
Output of internal reference	10 MHz or 100 MHz			
Output power	0 dBm			
Output impedance	50 Ω			
<b>High Performance Phase Synchronization Clock</b>	3 GHz			
<b>Phase Lock to External Reference</b>	5 MHz		250 MHz	Option VREF
<b>External reference frequency resolution</b>	1 MHz			Option VREF
<b>Reference Input Level</b>				
10 MHz or 1-250 MHz	-5 dBm	0 dBm	+10 dBm	
<b>Lock Range</b>				
10 MHz or 1-250 MHz			±1.5 ppm	
<b>Reference Input Impedance</b>		50 Ω		

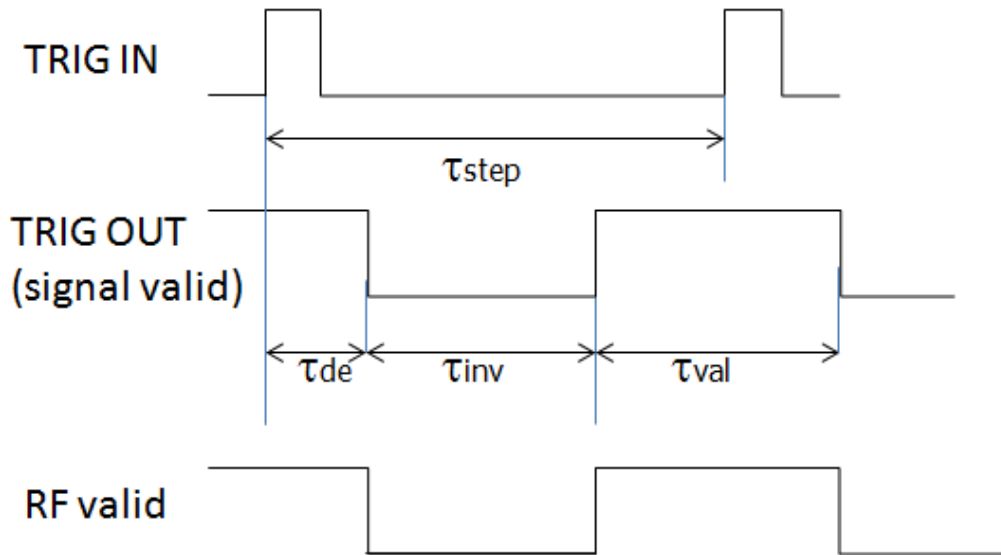
## Sweeping Capability

PARAMETER	MIN	TYPICAL	MAX	NOTE
<b>Sweep Type</b>	List, linear, logarithmic, sawtooth, triangle, random			
<b>Frequency Sweep Range</b>	Full range			
<b>Sweep Parameters</b>	Frequency, power, phase			
Step time ( $t_{step}$ )	500 μs 200 ns 800 ns		19998 s 19998 s	Option UFS, within +/- 200 MHz Option UFS, within full range
Settling time ( $t_{inv}$ )				To stabilize phase and amplitude, depends on frequency step
Time resolution		2 ns		
Timing accuracy per point		2 ns		

## Trigger Capability

PARAMETER	MIN	TYPICAL	MAX	NOTE
<b>Trigger Types</b>	Continuous, single (point), gated, gated direction			
<b>Trigger Source</b>	External, bus (LAN, USB, GPIB)			
<b>Trigger Modes</b>	Continuous free run (AUTO), trigger and run, reset and run			
Trigger uncertainty		+/- 8 ns		
External trigger delay	0		10 s	Settable
External delay resolution		2 ns		
<b>Trigger Polarity</b>	Rising, falling			





### External Multi-Function Inputs

PARAMETER	MIN	TYPICAL	MAX	NOTE
Connector Type	MF1 IN, MF2 IN			see chapter CONNECTORS, IOS
Application	Ext Pulse, Ext trigger			
Nominal input impedance	DC 10k $\Omega$ and AC 50 $\Omega$ (nom)			
Threshold voltage	0.85V	0.9 V	0.95 V	
Nominal input voltage	0 V		3.3 V	TTL compatible
Hysteresis		60 mV		

### External Multi-Function Outputs

PARAMETER	MIN	TYPICAL	MAX	NOTE
Connector Type	MF1 OUT, MF2 OUT			see chapter CONNECTORS, IOS
Application	Pulse video, Marker signals			
Nominal output impedance	TBD			
Nominal output voltage	0 V		3.3 V	LVTTL

### Fast Control Port (Option FCP)

PARAMETER	
<b>Interface</b>	Parallel, bidirectional LVDS with 100 $\Omega$ termination at receiver
Common mode level	typ. 1.2V
Differential input threshold	typ. +/-100mV
Differential output voltage	typ. 300mV
Connector type	FCP IO, 36-pin mini-D female (3M MDR 102 Series)
<b>Mode: IQ data streaming</b>	
Sample rate (IQ samples)	125 MHz (optional 250 MHz)
Input/output format, interleaved clock	data (16 bits), clock signal, valid signal
Valid IQ data input to rf output delay at 125 MHz sample rate	typ. TBD ns
<b>Mode: Segment ID streaming</b>	
Input format	data (16 bits), valid signal (pin pair 18/36 signal must be static low or high)
Valid segment ID input to rf output delay (immediate segment changeover)	typ.TBD ns
Valid segment ID jitter	+/- 8 ns
Pin mapping	
<b>Mode: Parameter setting</b>	
Parameter	Frequency (up to 48bit), amplitude, phase
Input format	address (8 bits), data (8 bits), valid signal

Pin assignment	Pin (P/N)	Signal	Pin (P/N)	Signal	Pin (P/N)	Signal
	1/19	data bit 0	2/20	data bit 1	3/21	data bit 2
	4/22	data bit 3	5/23	data bit 4	6/24	data bit 5
	7/25	data bit 6	8/26	data bit 7	9/27	data bit 8
	10/28	data bit 9	11/29	data bit 10	12/30	data bit 11
	13/31	data bit 12	14/32	data bit 13	15/33	data bit 14
	16/34	data bit 15	17/35	valid	18/36	clock

### External Analog I/Q Data Inputs (Option AIQ)

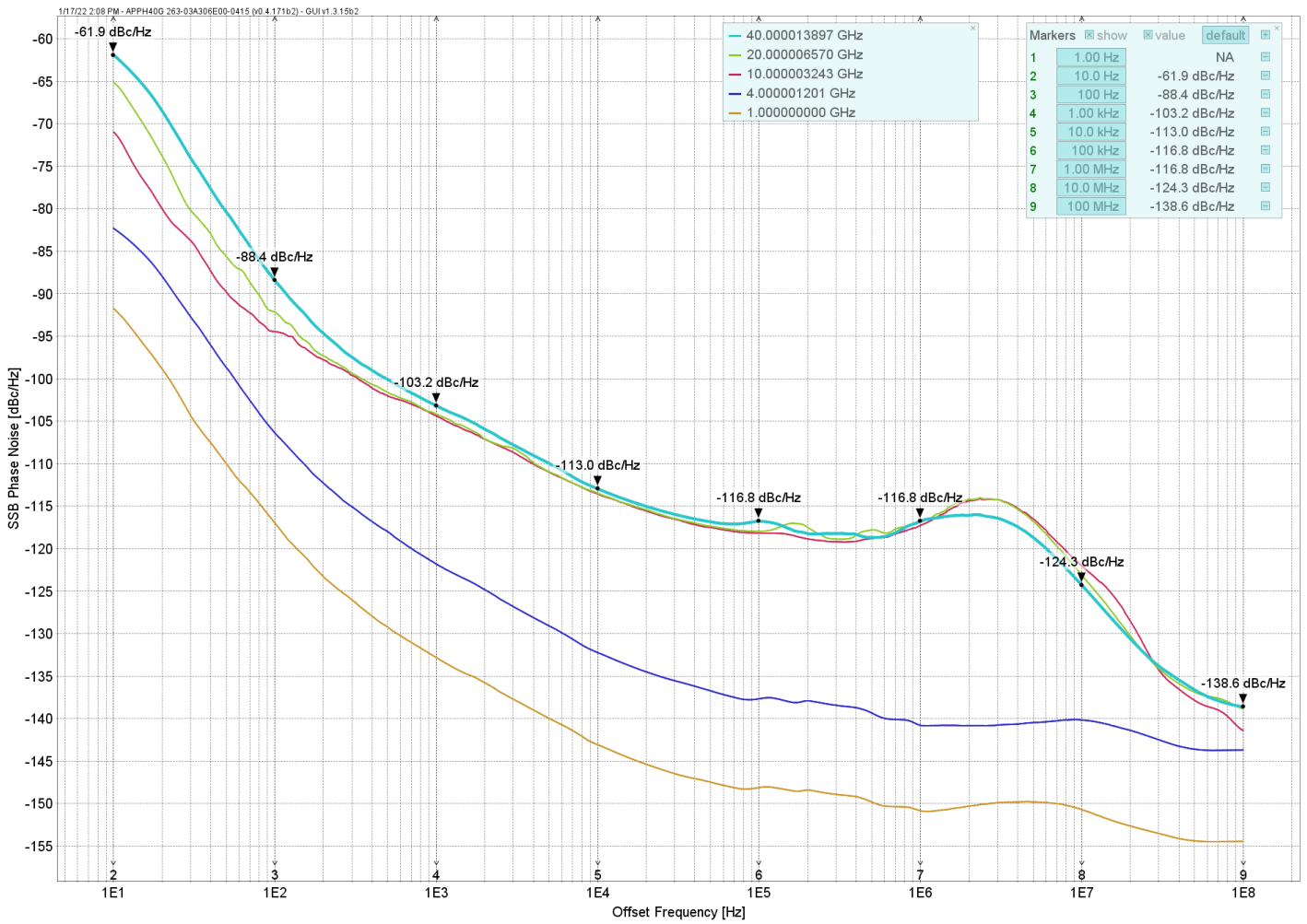
PARAMETER	MIN	TYPICAL	MAX	NOTE
Analog bandwidth		50 MHz		
Input impedance		50 Ω		
Voltage range	-0.5 V		0.5 V	
Full scale voltage		0.5Vrms		$\sqrt{I^2+Q^2}$
Input impedance		50 Ohms		
Connector Type		I IN, Q IN		see chapter CONNECTORS, IOS

### Multi-Channel Performance

PARAMETER	MIN	TYPICAL	MAX	NOTE
Isolation between Channels		>90 dB		
Relative Phase Stability		tbd		

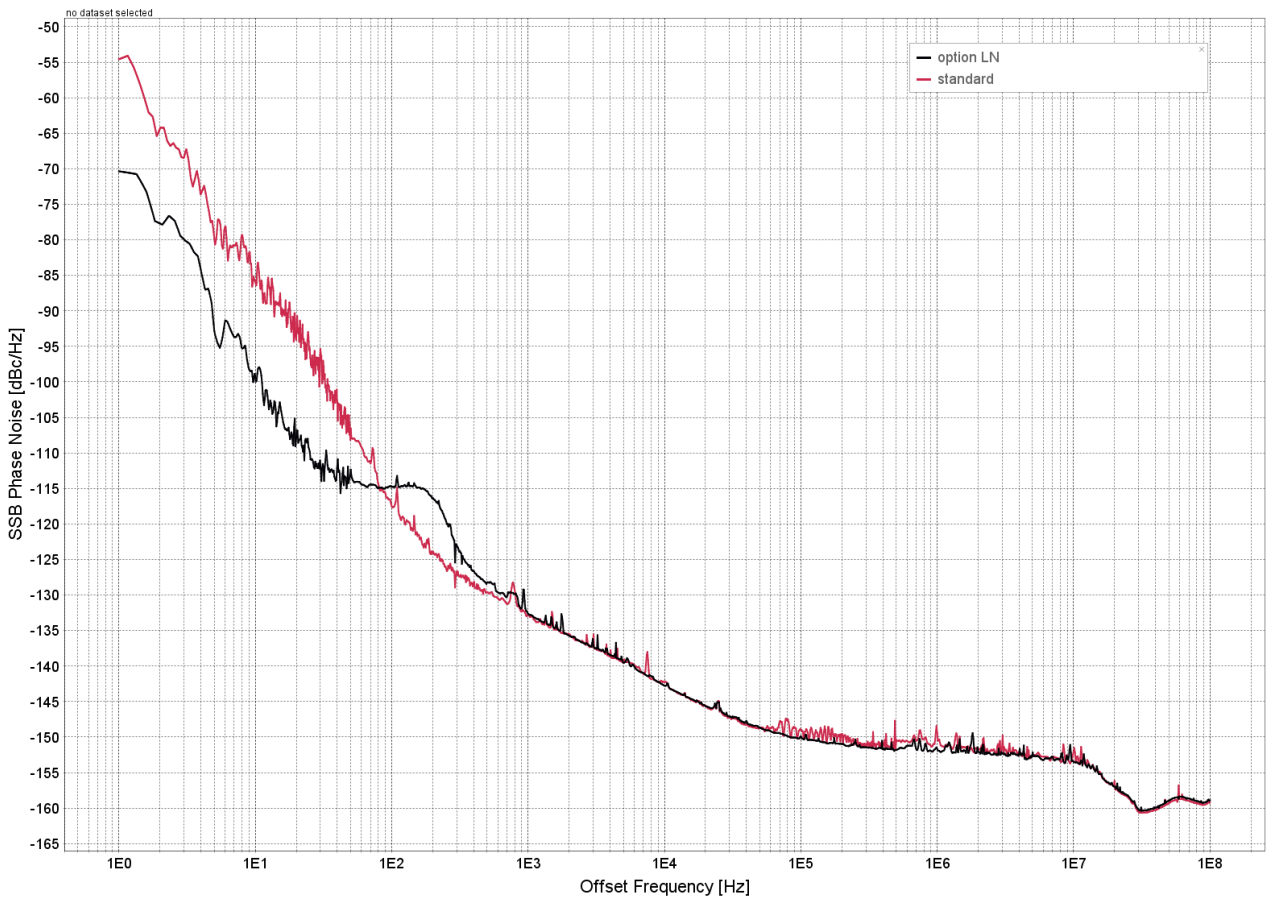
# TYPICAL PERFORMANCE CURVES

**Figure 1: SSB Phase Noise Performance, CW without option LN, Pout = 10 dBm**

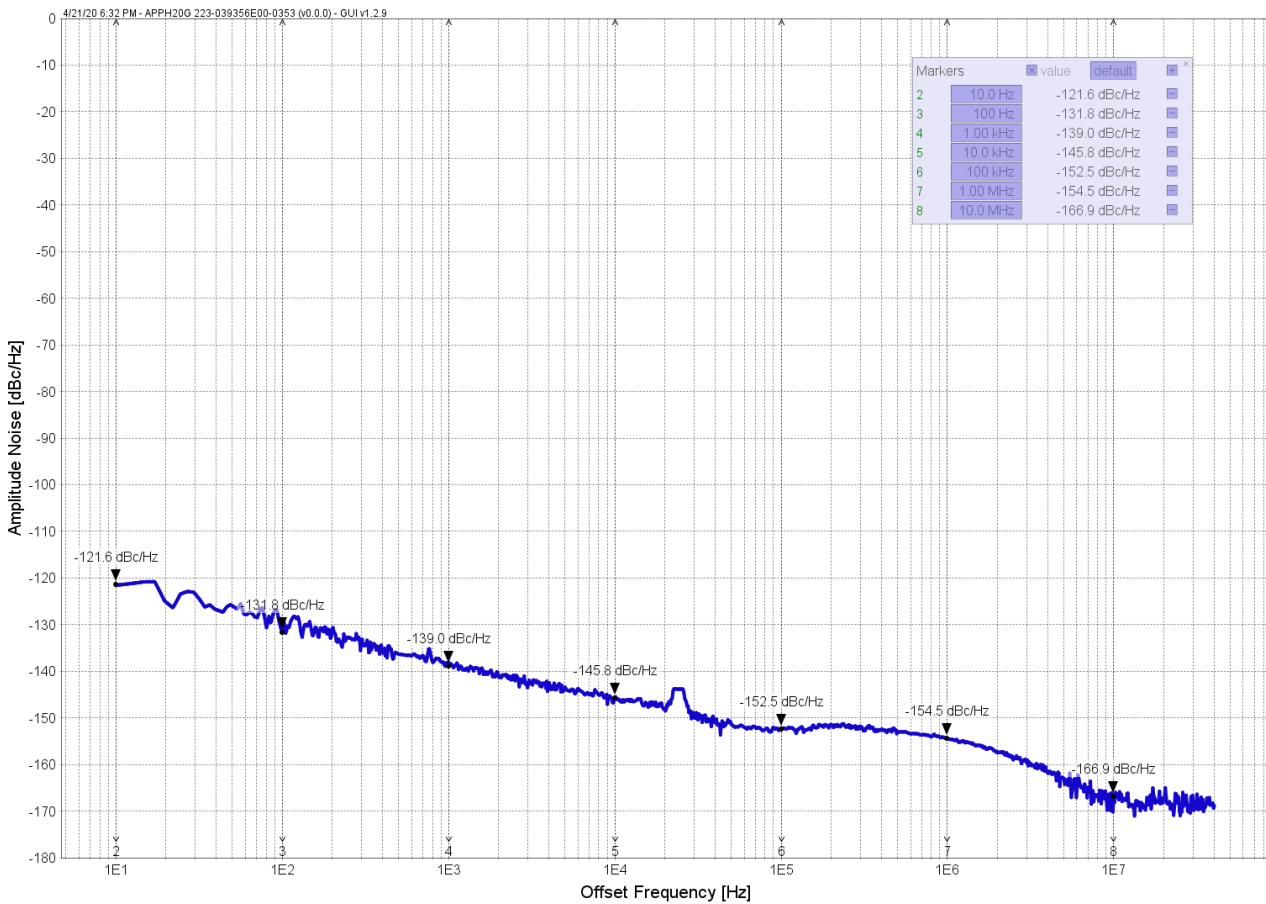


Offset → RF ↓	1 Hz	10 Hz	100 Hz	1 kHz	10 kHz	100 kHz	1 MHz	floor
100 MHz		-119	-135	-148	-155	-156	-158	-159
1 GHz		-100	-114	-129	-140	-150	-152	-160
4 GHz		-87	-102	-118	-129	-139	-140	-151
40 GHz		-62	-89	-103	-113	-117	-117	-139

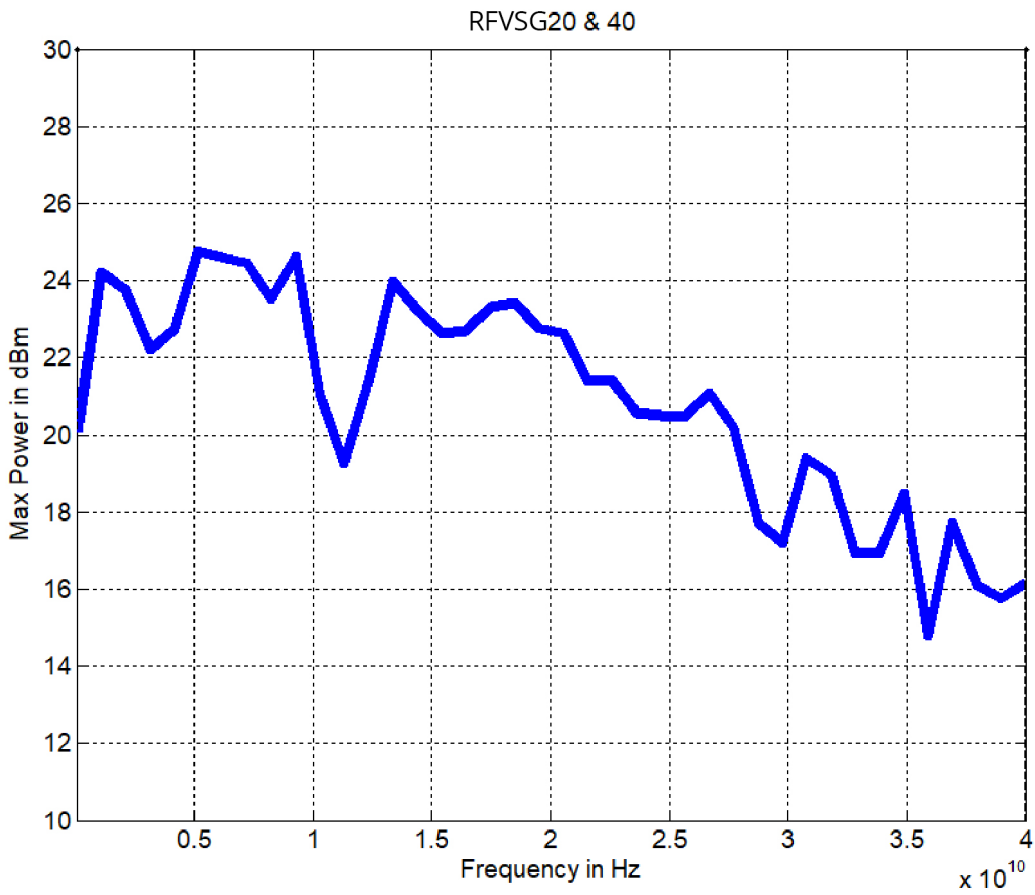
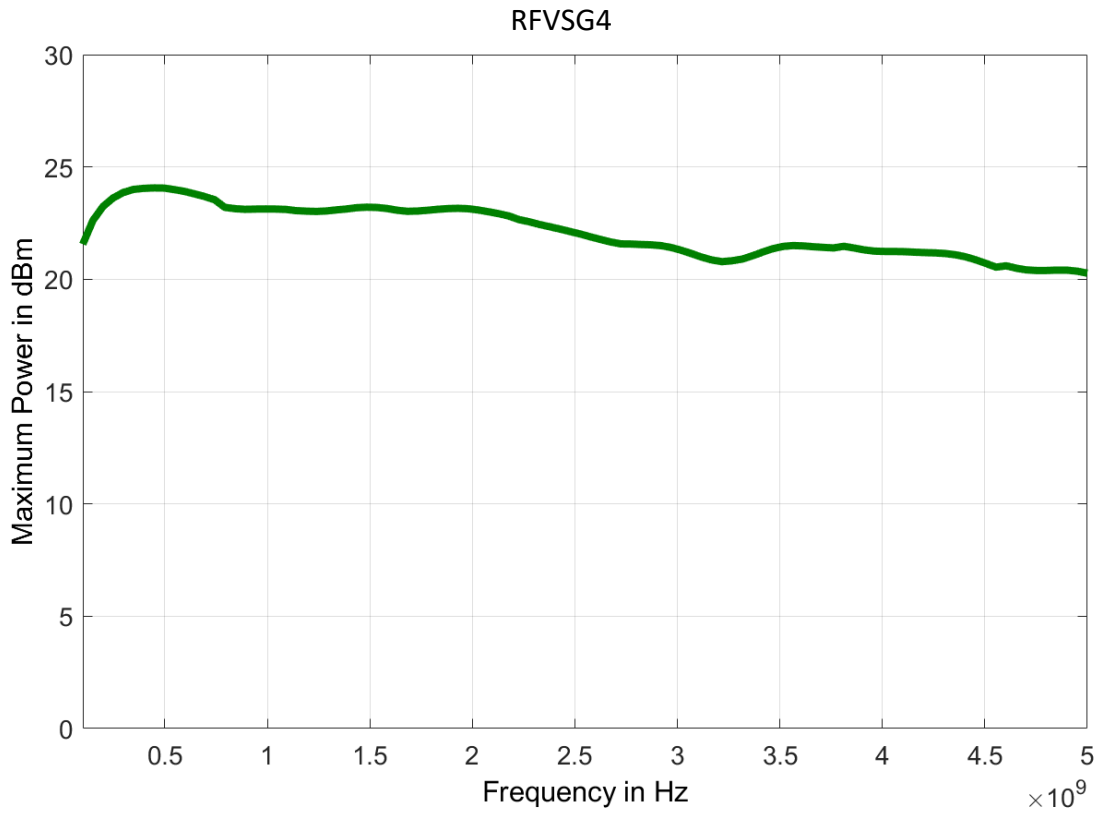
**Figure 2: SSB Phase Noise Performance, CW with option LN, 1 GHz, Pout = 10 dBm**



**Figure 2a: Amplitude Noise, 2 GHz, Pout = 10 dBm**



**Figure 3: Maximum Output Power**



**Figure 4: Harmonic performance at 0 dBm**

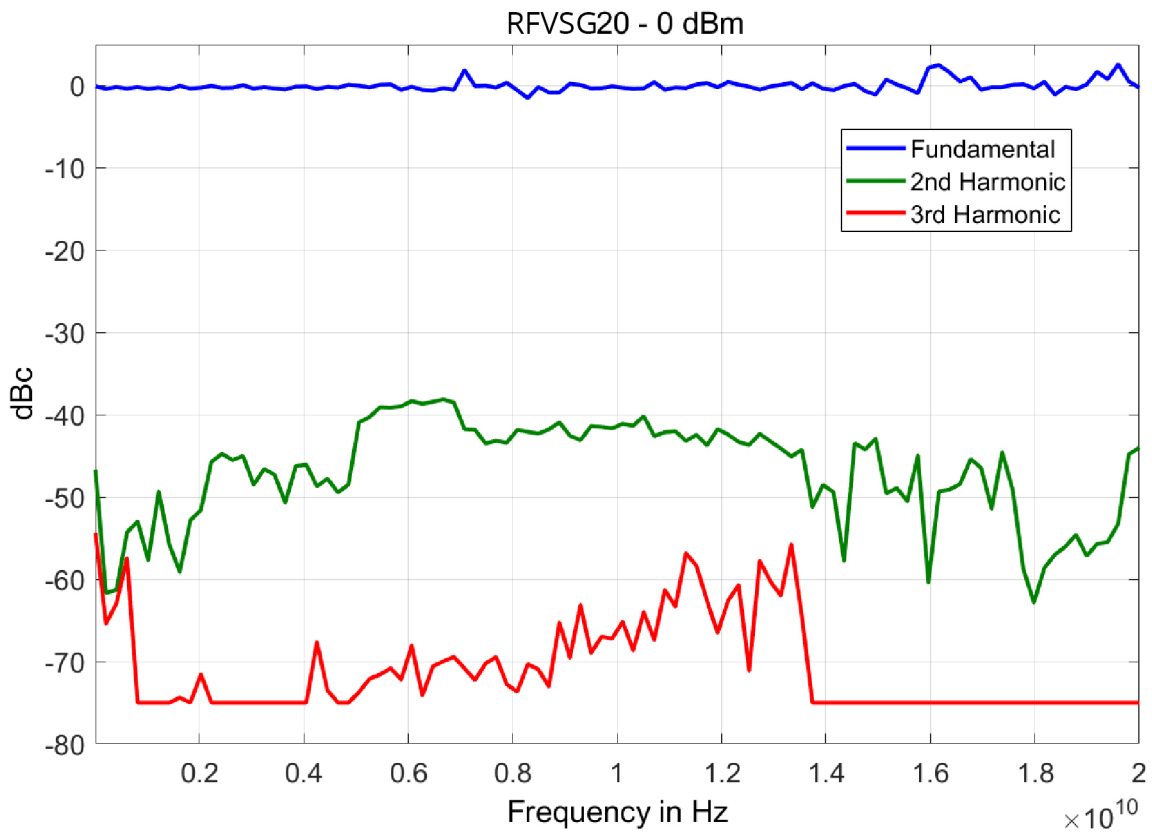
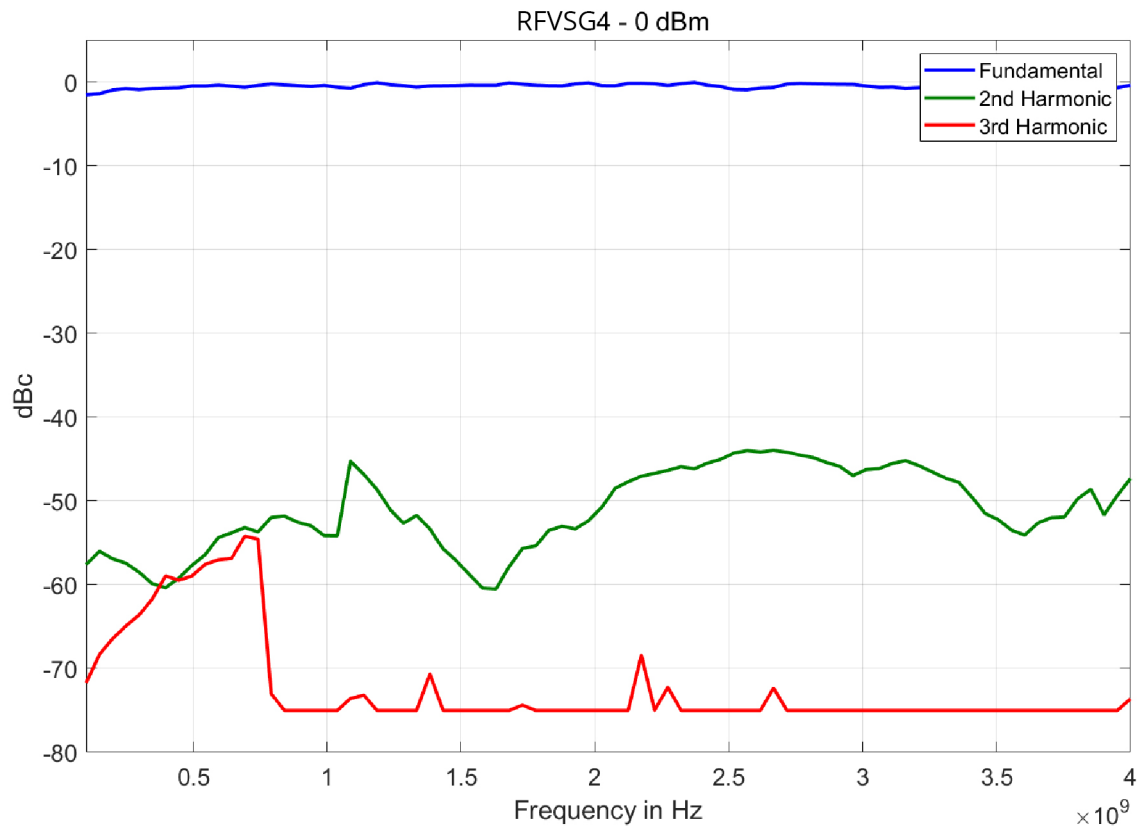
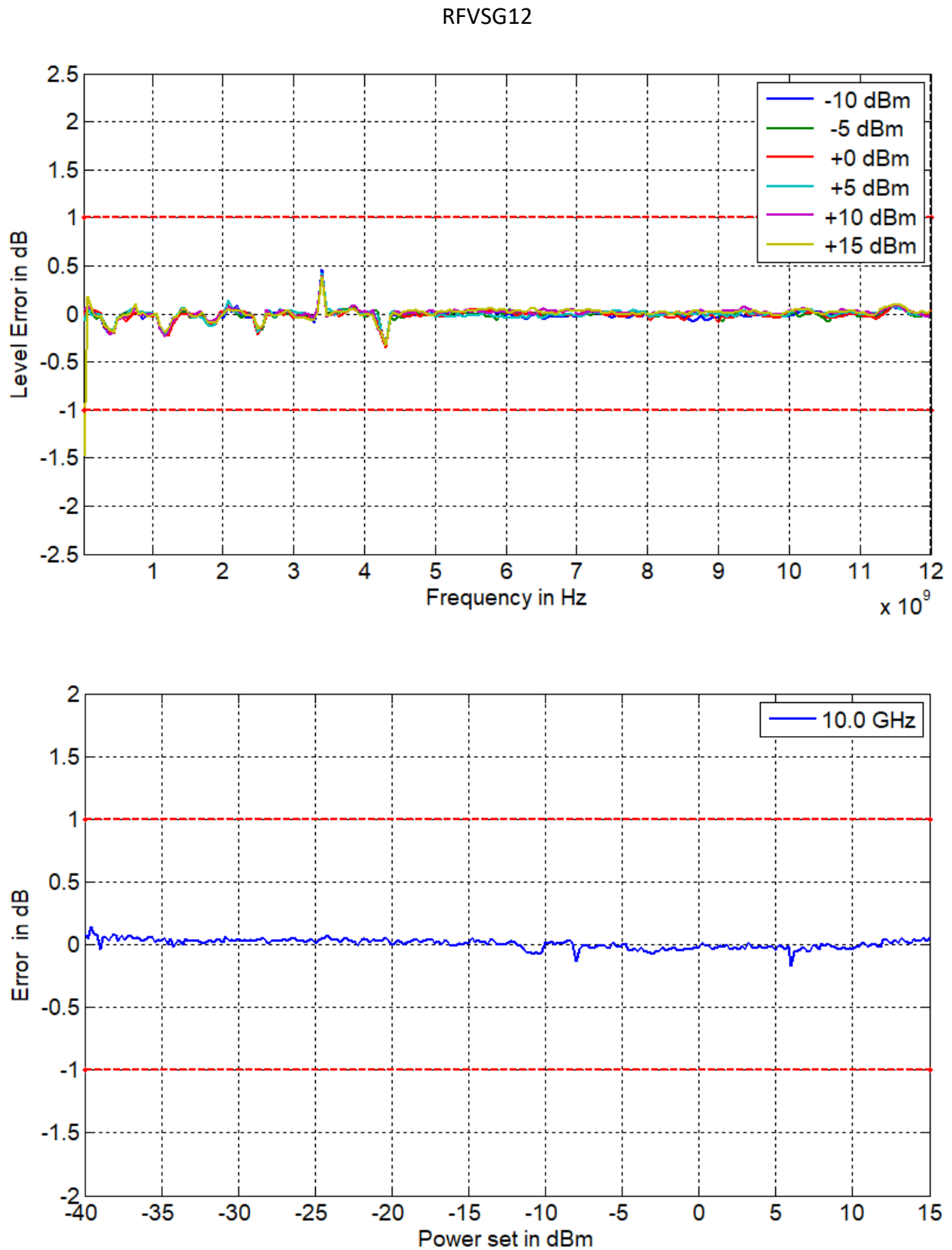
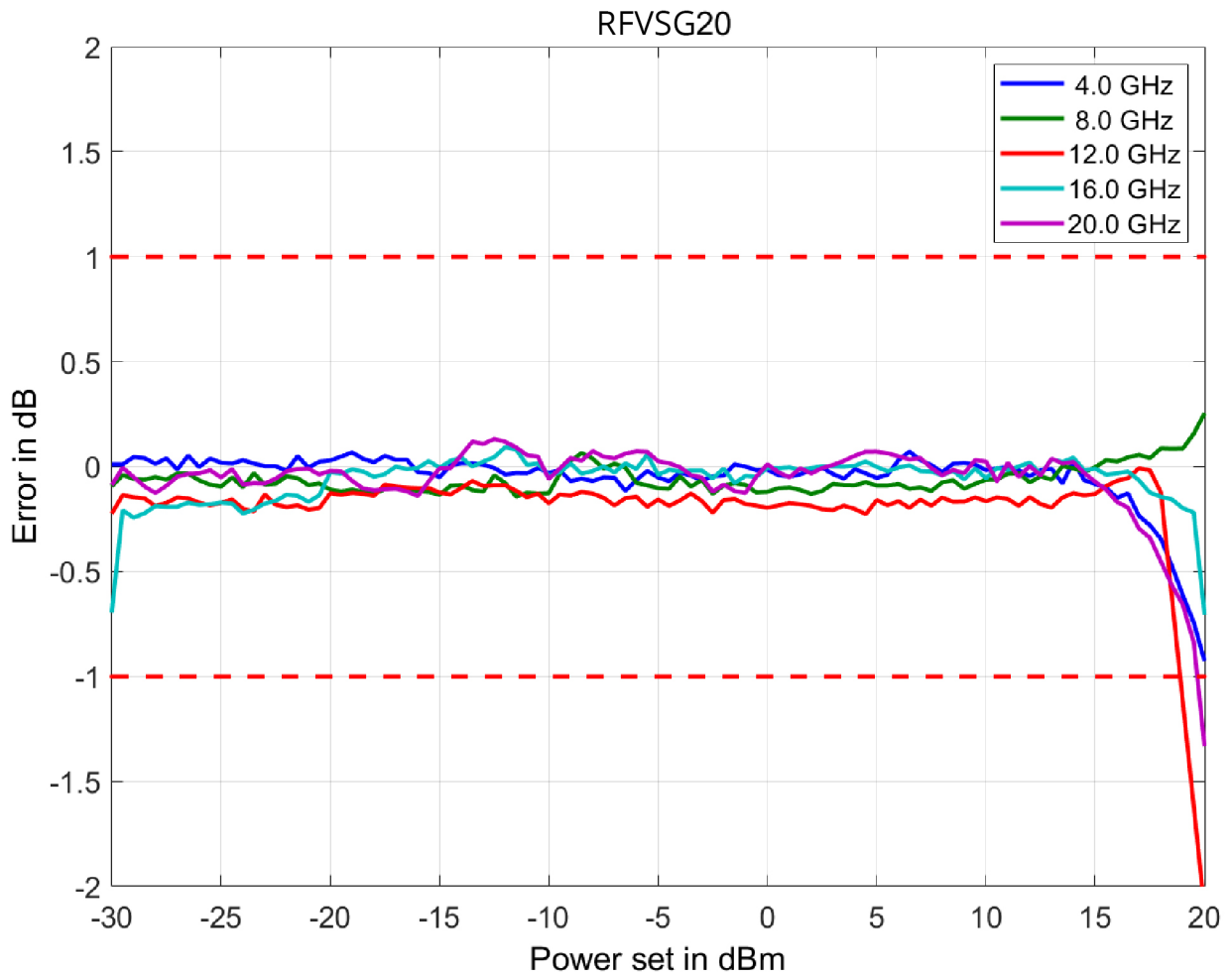
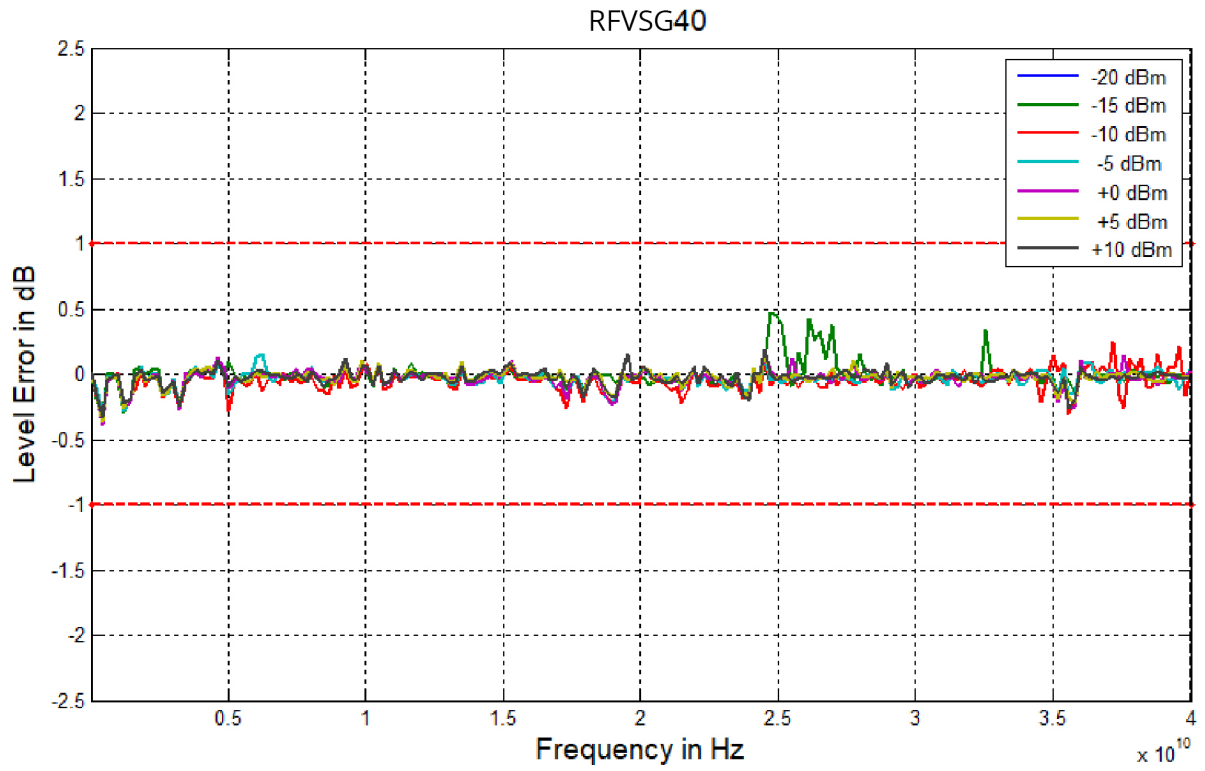


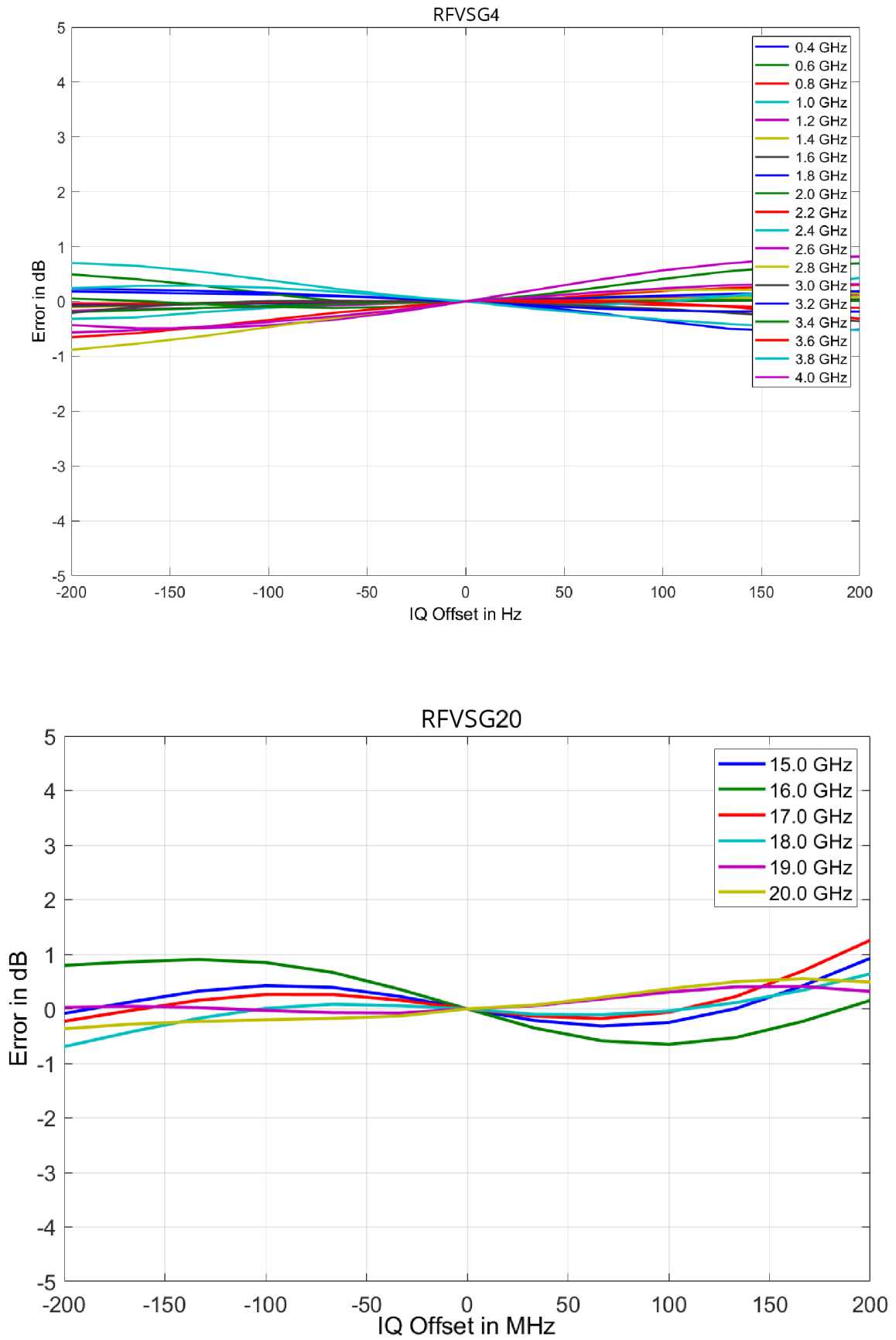
Figure 5: Level accuracy



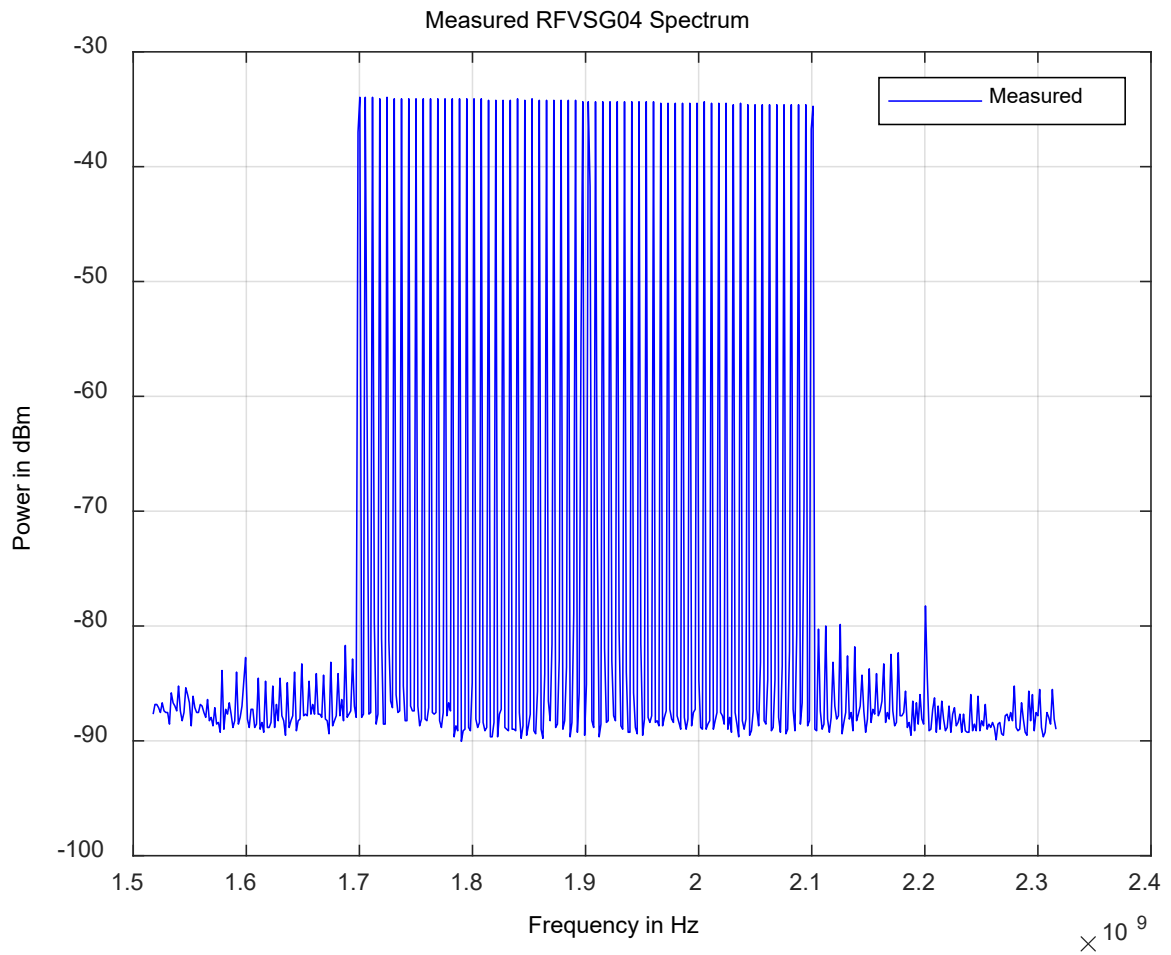




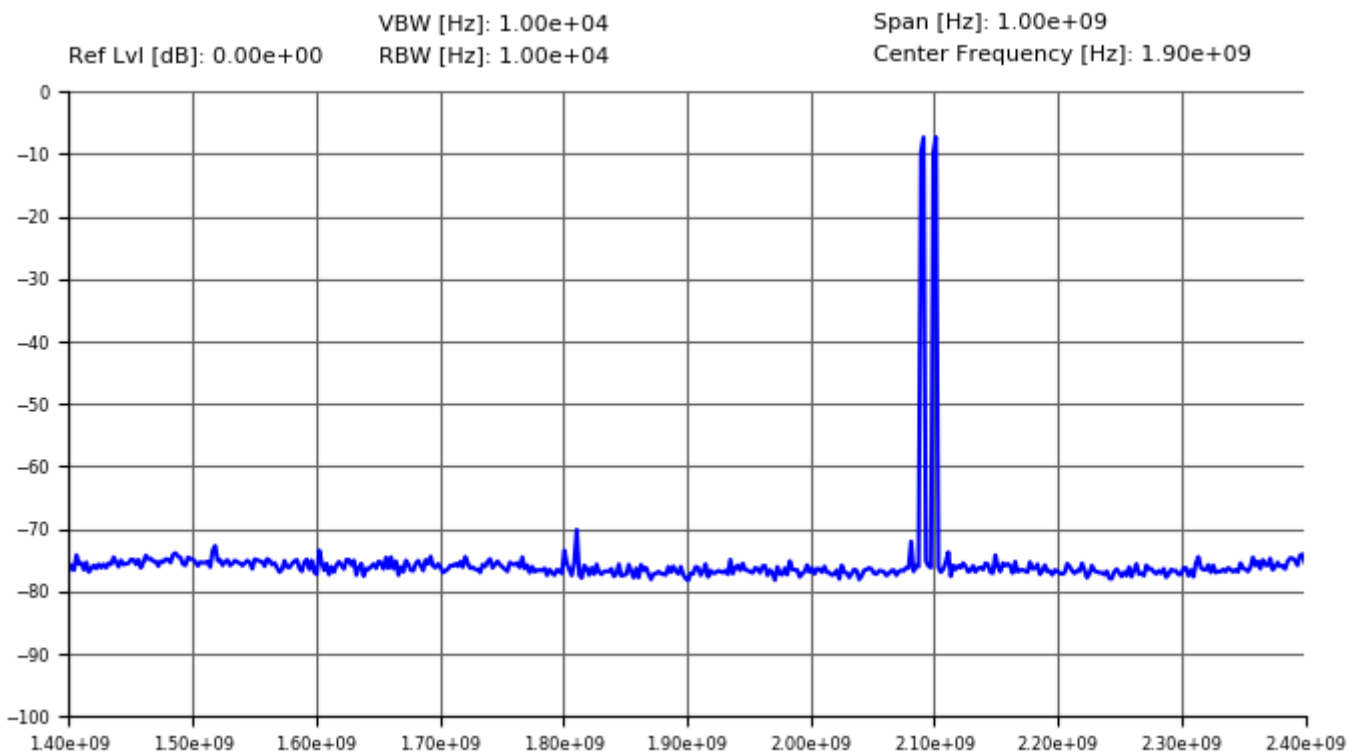
 **Figure 6: IQ Relative Response (measured)**



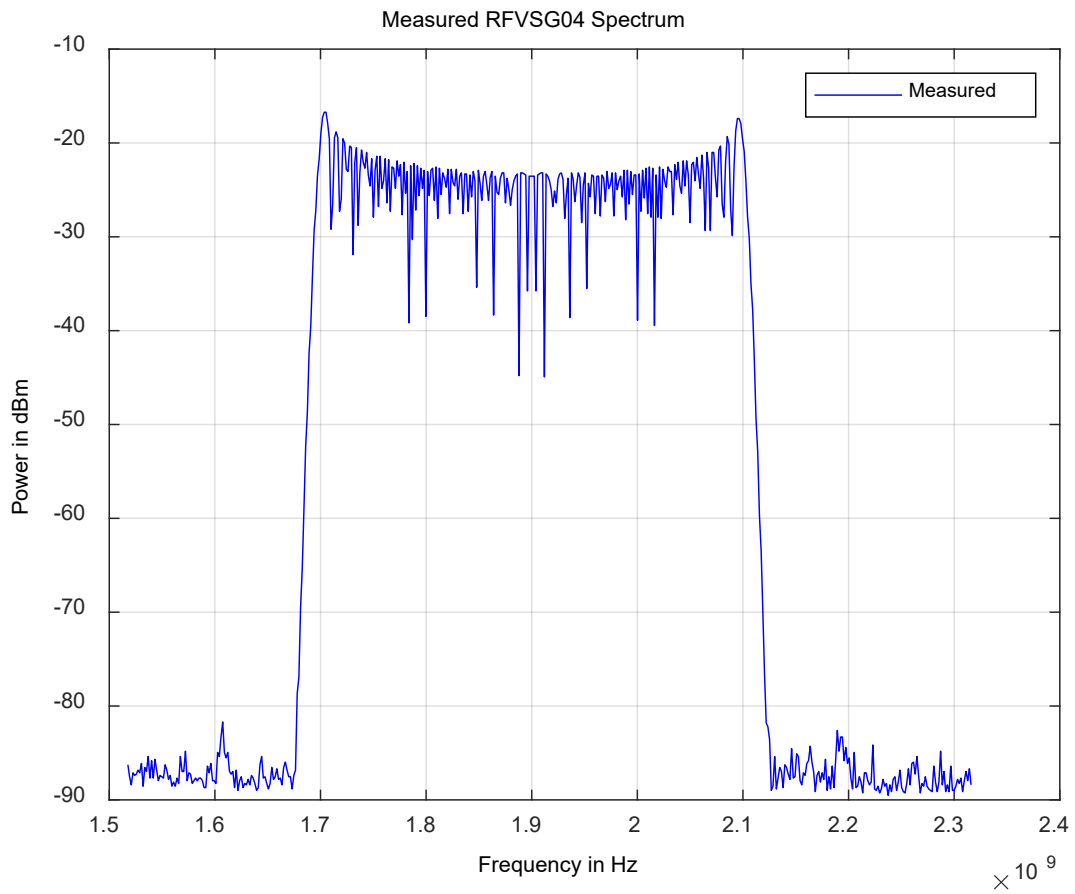
**Figure 7: 64-tone 400 MHz bandwidth signal**



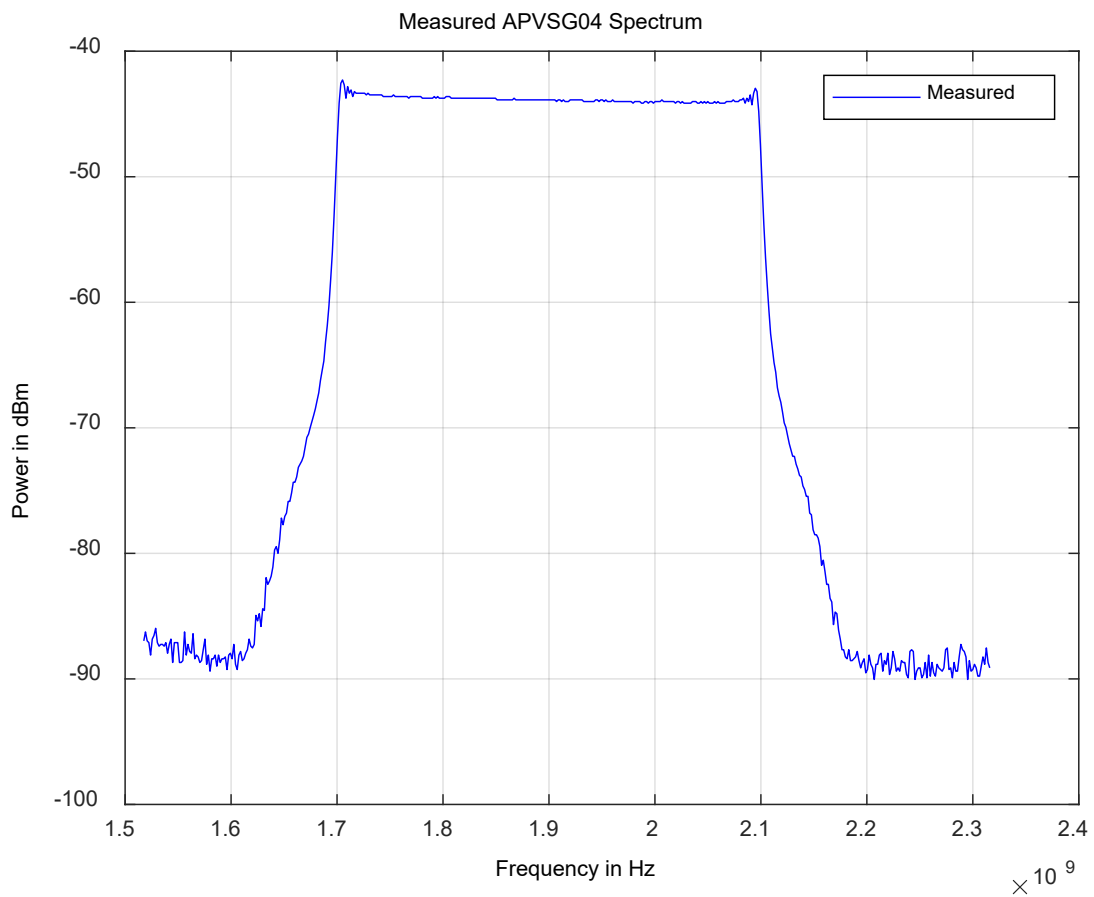
**Figure 8: Two-tone sideband rejection**



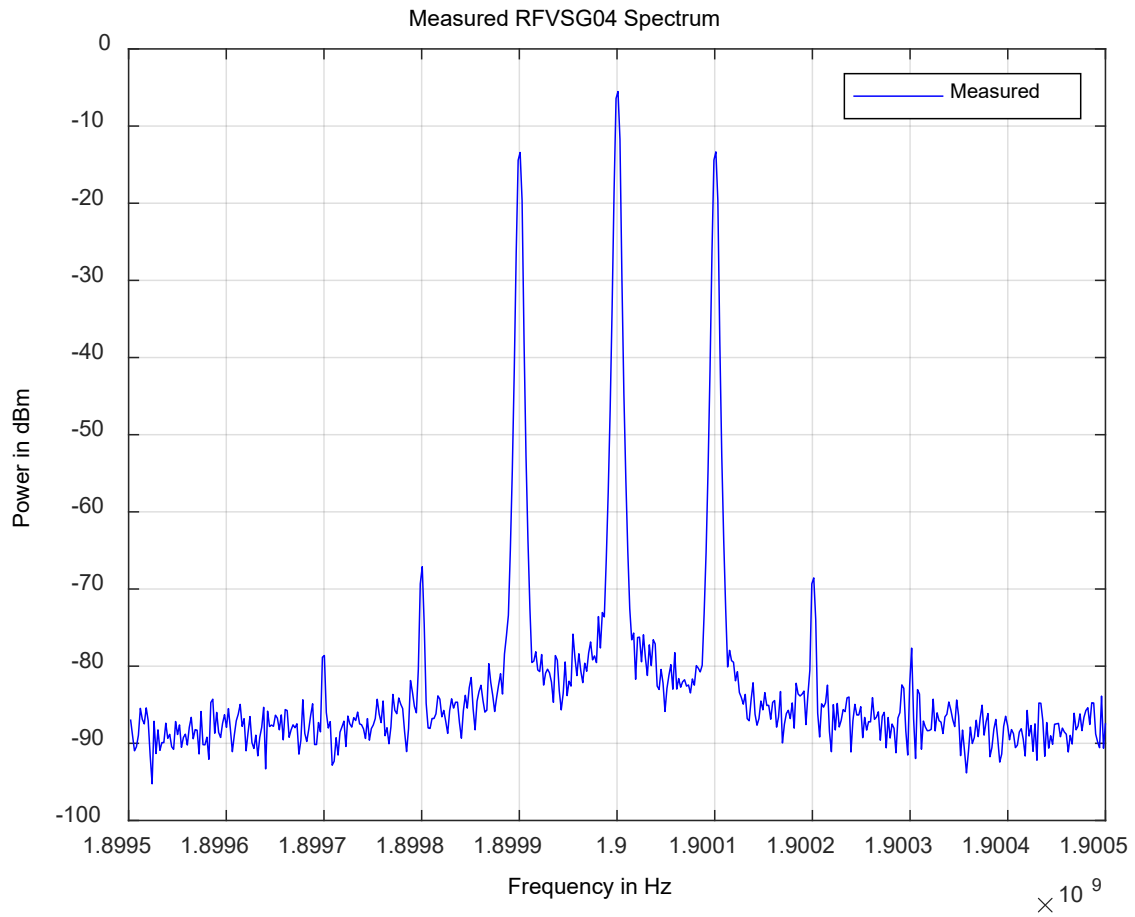
**Figure 9: Wideband FM (1MHz rate, 200 MHz deviation)**



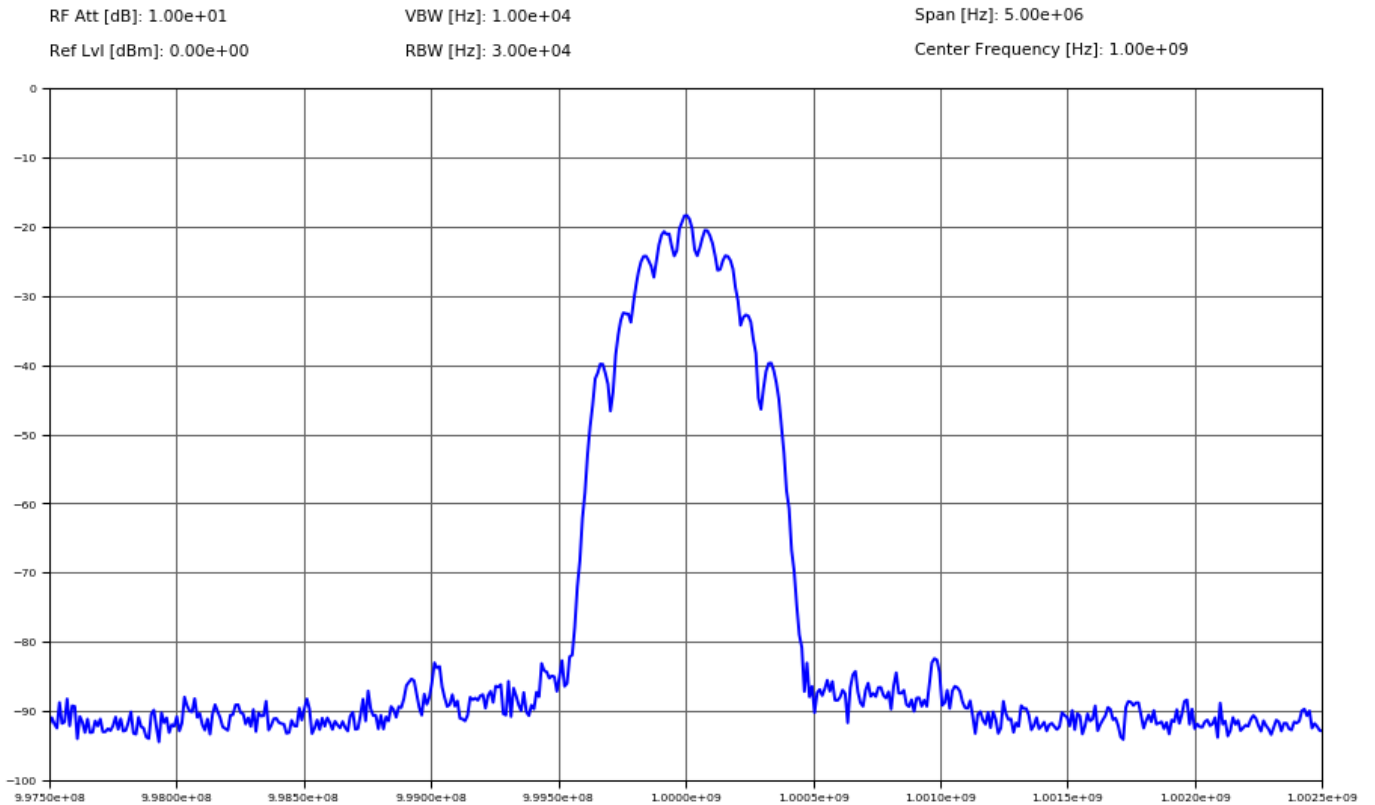
**Figure 10: Pulsed chirp (10 microseconds, 400 MHz bandwidth)**



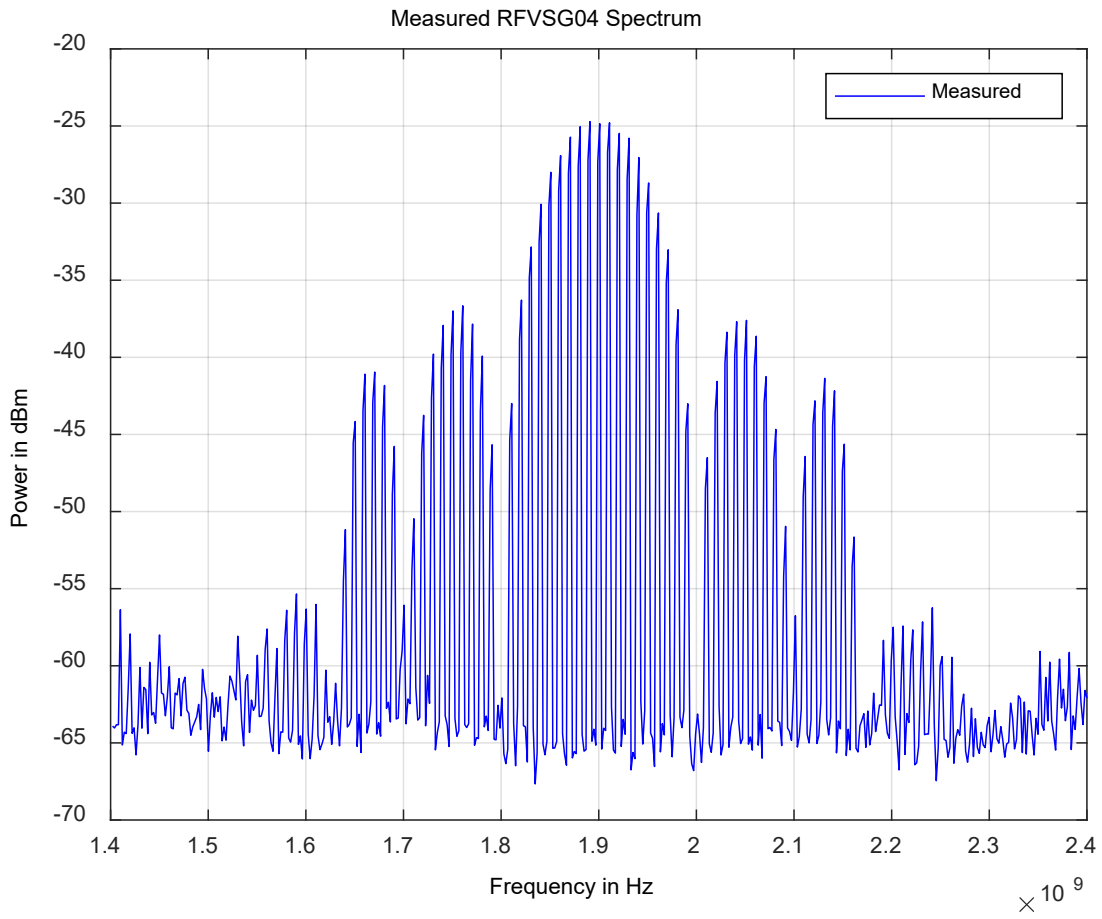
**Figure 11: Amplitude modulation (1 kHz rate, 80% depth)**



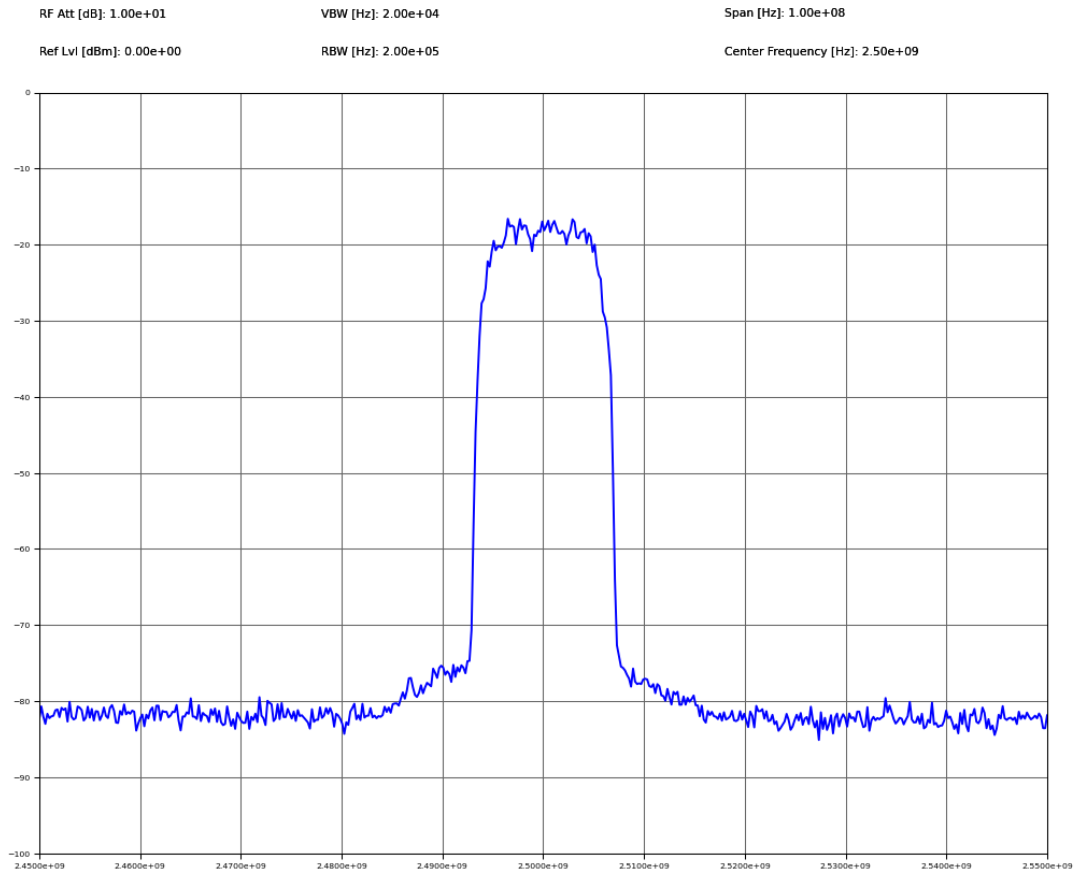
**Figure 12: DME Spectrum (X channel, raised cosine filter)**



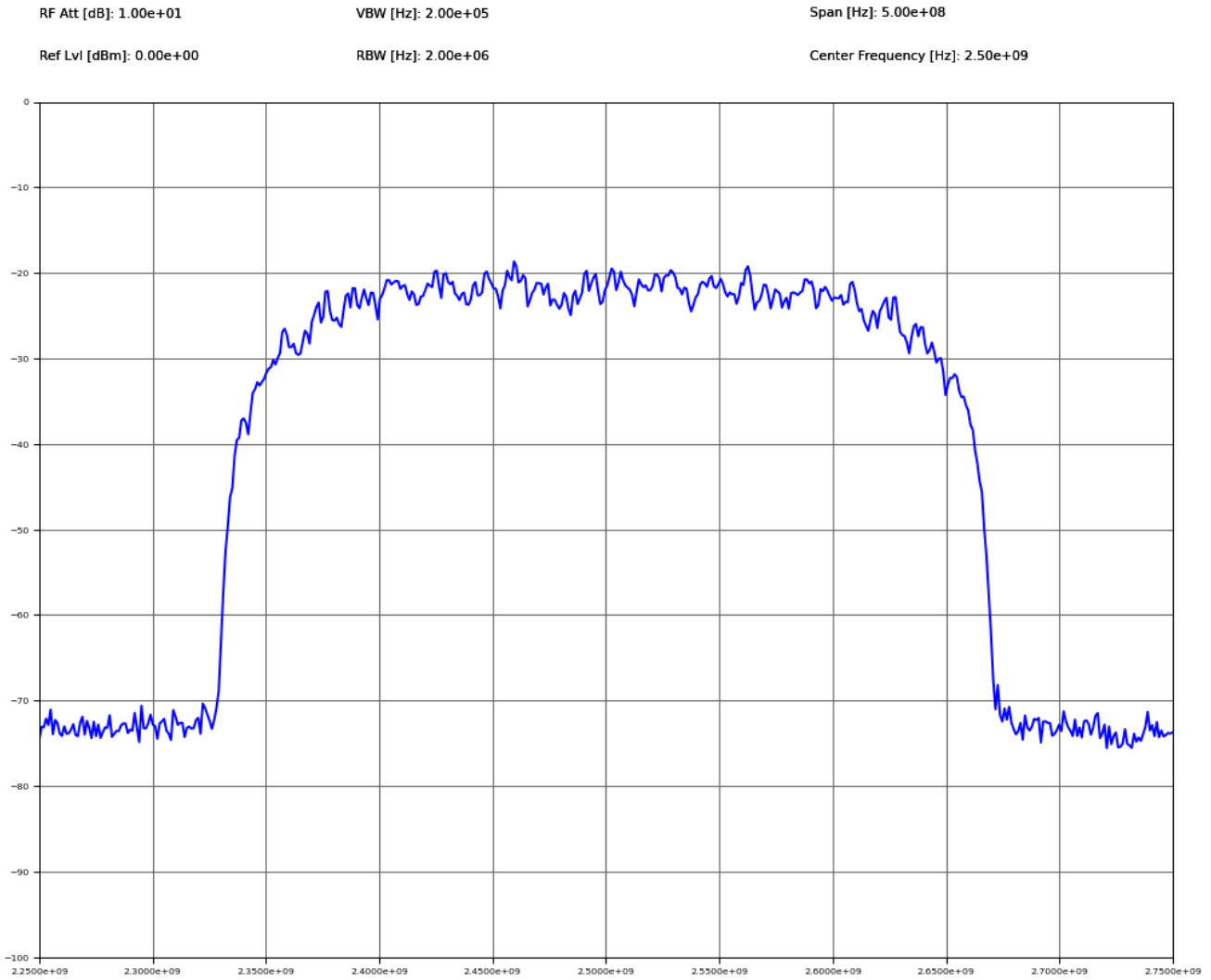
**Figure 13: Pulse modulation (10 MHz rate, 10 ns pulse width)**



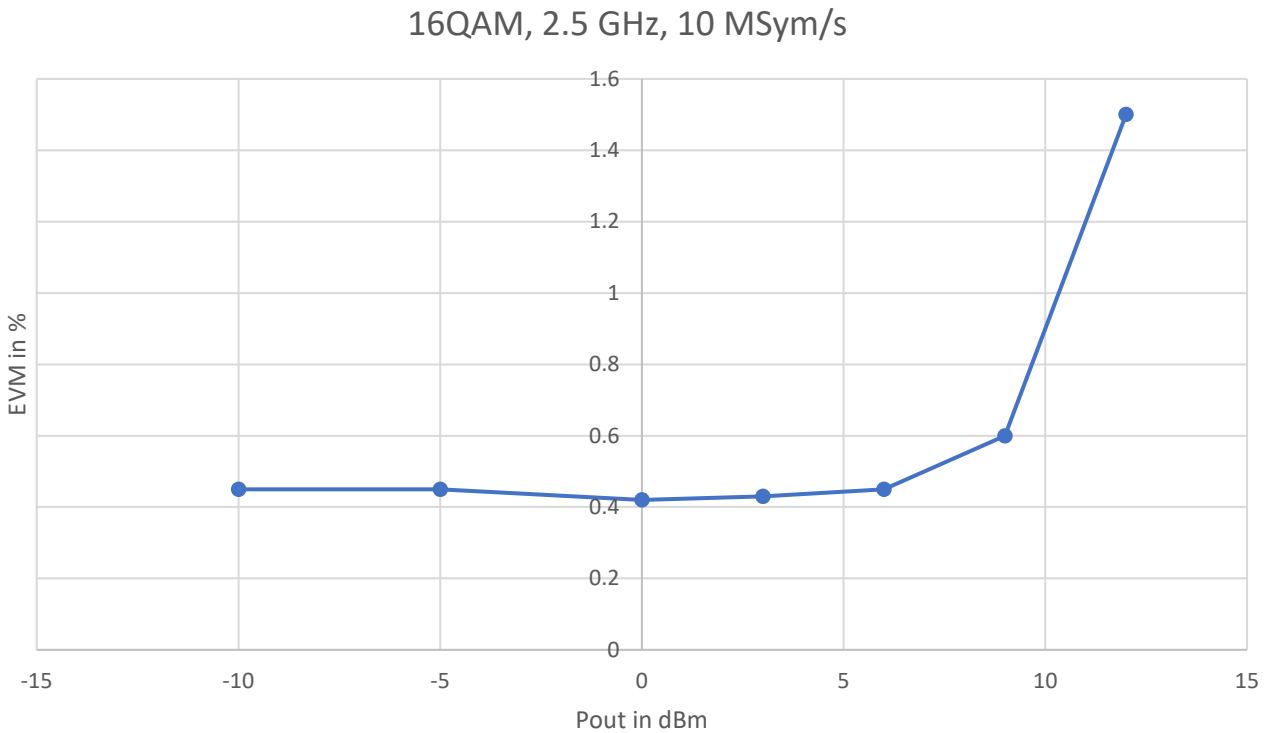
**Figure 14: 256QAM 10 MS/s**



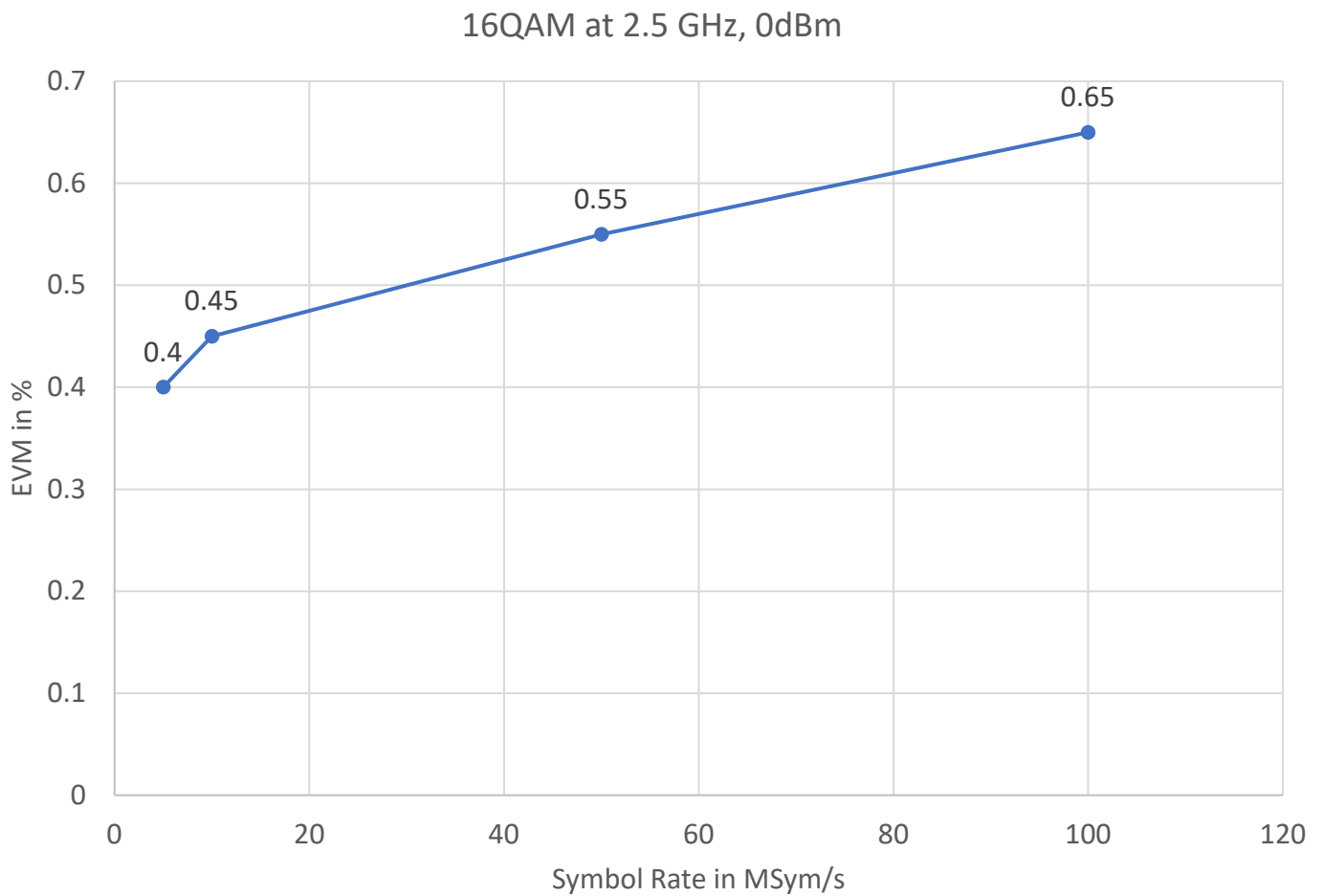
**Figure 15: 16QAM 250 MS/s**



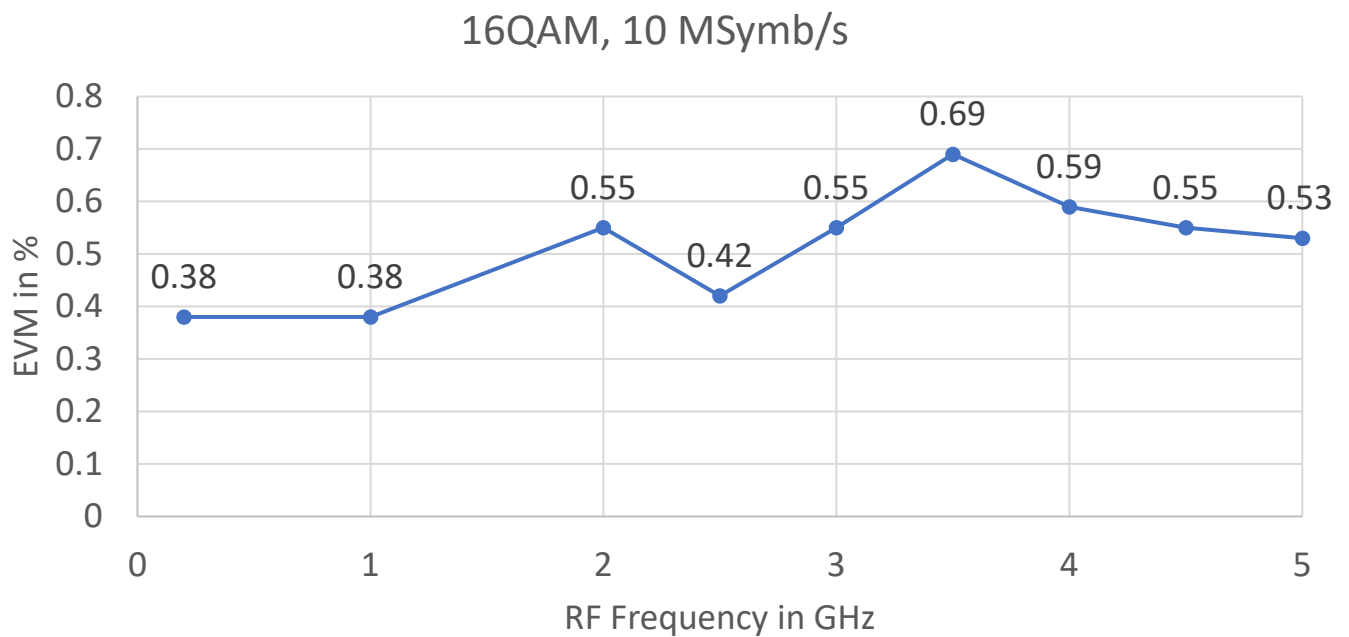
**Figure 16: EMV vs Output Power, 16QAM, 10 MS/s, 2.5 GHz**



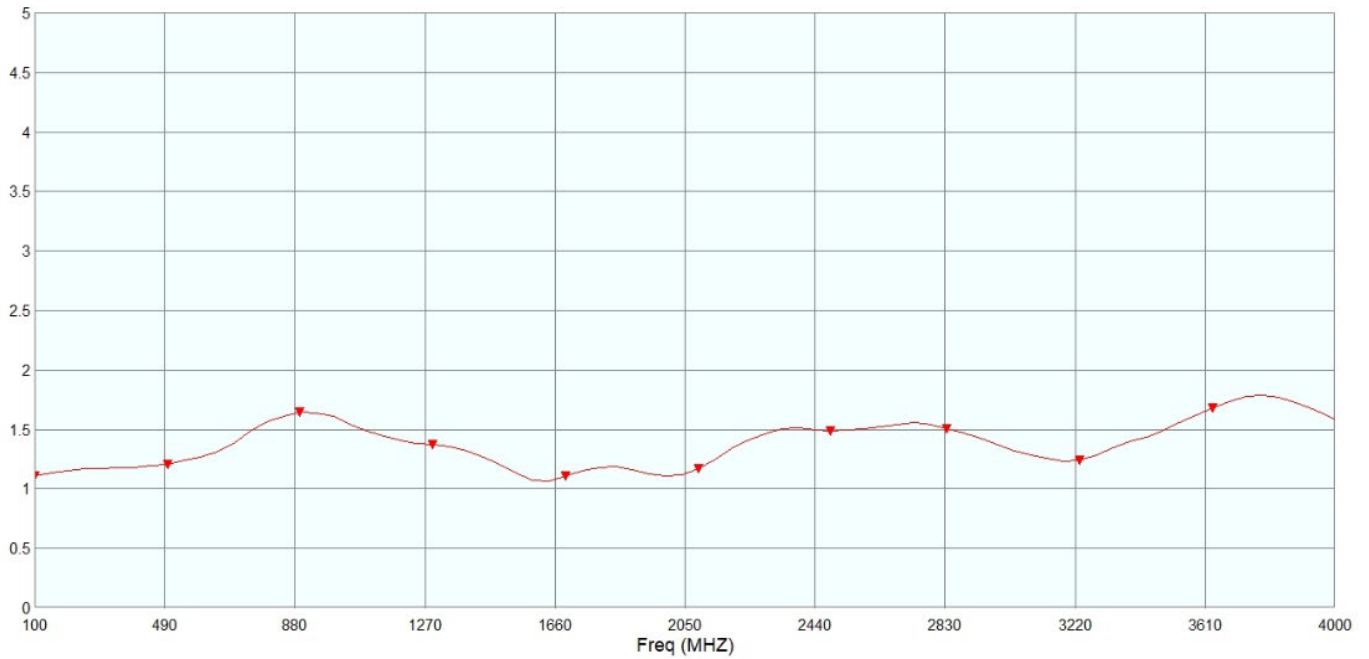
**Figure 17: EMV vs Symbol Rate, 16QAM**



**Figure 18: EMV vs RF Frequency, 16QAM, 10 Msymbols/s**



**Figure 19: Typical VSWR (RFVSG04)**



**Figure 20: Typical VSWR (RFVSG12 & RFVSG20)**

tba

**Figure 21: User Interface**

The screenshot displays the Anapico APVSG GUI with the following settings and visualizations:

- Carrier Section:** Frequency is set to 1.000 GHz, Power to 0.00 dBm, and Phase to 0°. A red "RF OFF" button is visible.
- Modulation Section:** The "Generator" tab is active, showing "Pulsed Chirp" modulation. Parameters include Pulse Period (5.0 μs), Pulse Width (3.0 μs), Chirp Start (0 Hz), and Chirp Stop (10.000 MHz). A "Generated" button is present.
- VNA Plot:** A large circular plot showing a red circle on a grey background, representing the VNA measurement.
- Waveform Plot:** A time-domain plot showing the amplitude of the signal over time, with a red line and a blue line representing different components.
- Control Elements:** Playback Rate (500.000 MHz), Backoff (0.00 dB), Peak Power (-0.0 dBFS), and buttons for "Export to File", "Upload to Device", and "Modulation OFF".



# CONNECTORS, IOS

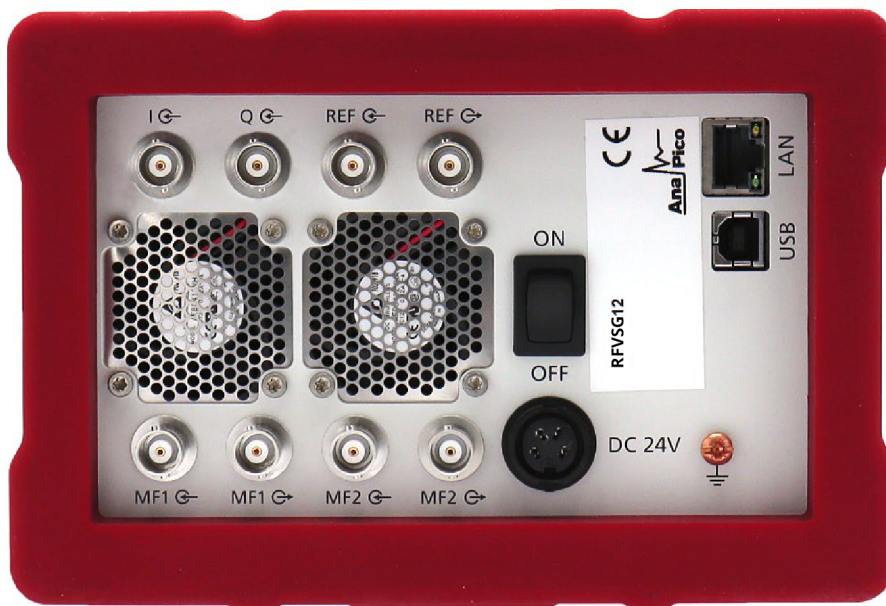
## Front panel (single channel model):

LABEL	TYPE	DESCRIPTION	OPTION
RF 50 Ω	N female (RFVSG04/RFVSG06/RFVSG12) SMA female (RFVSG20) K (2.92mm) female (RFVSG40)	RF output	



## Rear panel (single channel model):

LABEL	TYPE	DESCRIPTION	OPTION
I & Q IN	BNC female	Input for analogue in-phase signals	AIQ
REF IN, REF OUT	BNC female	Reference frequency input & output	
USB	USB type B	Remote programming interface	
LAN	RJ-45	Remote programming interface	
DC24V	DC power plug female	Power of Instrument	
MF1 IN, MF2 IN	BNC female	Multi-function inputs: user-configurable (e.g. trigger, external pulse)	
MF1 OUT, MF2 OUT	BNC female	Multi-function outputs: user-configurable (e.g. trigger, marker)	
ON/OFF	SWITCH	Turns the device on or off.	
GROUND SCREW		Connects the device to ground reference	



**Front panel (2U multi (2 to 4) channel model):**

LABEL	TYPE	DESCRIPTION	OPTION
RF OUT (for each channel)	SMA female / K (2.92mm) female (RFVSG40-X)	RF output	



**Rear panel (2U multi (2 to 4) channel model):**

LABEL	TYPE	DESCRIPTION	OPTION
USB	USB type B	Remote programming interface	
LAN	RJ-45	Remote programming interface	
GPIB	24-pin female	Remote programming interface	GPIB
REF IN	SMB female	Reference frequency input	
REF OUT	SMB female	Reference frequency output	
CLK IN	SMB female	High-stability reference input	
CLK OUT	SMB female	High-stability reference output	
FCP (for each channel)	36-pin mini-D female	Fast control port	FCP
MF1 IN, MF2 IN (for each channel)	SMB female	Multi-function inputs: user-configurable (e.g. trigger, external pulse)	
MF1 OUT, MF2 OUT (for each channel)	SMB female	Multi-function outputs: user-configurable (e.g. trigger, marker)	
I IN, Q IN (for each channel)	SMB female	Analog IQ-modulation inputs	AIQ



## ORDERING INFORMATION



HOST MODEL	PRODUCT	DESCRIPTION
RFVSG	RFVSG04	4 GHz model
RFVSG	RFVSG06	6 GHz model
RFVSG	RFVSG12	12 GHz model
RFVSG	RFVSG20	20 GHz model
RFVSG	RFVSG40	40 GHz model
RFVSG-X	RFVSG04-X	4 GHz model (X channels)
RFVSG-X	RFVSG06-X	6 GHz model (X channels)
RFVSG-X	RFVSG12-X	12 GHz model (X channels)
RFVSG-X	RFVSG20-X	20 GHz model (X channels)
RFVSG-X	RFVSG40-X	40 GHz model (X channels)
RFVSG(-X)	<b>Option LN</b>	Enhanced close-in phase noise & frequency stability
RFVSG(-X)	<b>Option LN+</b>	Enhanced close in phase noise & further enhanced long term frequency stability
RFVSG(-X)	<b>Option UFS</b>	Ultra-fast switching speed
RFVSG(-X)	<b>Option FCP*</b>	Fast control port, external digital I/Q data streaming (per channel)
RFVSG(-X)	<b>Option GPIB*</b>	GPIB interface
RFVSG(-X)	<b>Option SD</b>	MicroSD card slot for non-volatile storage of IQ data
RFVSG(-X)	<b>Option MOD</b>	Internal analog modulations
RFVSG(-X)	<b>Option IVM</b>	Internal digital modulation schemes
RFVSG	<b>Option AVIO</b>	Avionics (DME, VOR, ILS, Marker Beacon)
RFVSG(-X)	<b>Option VREF</b>	Variable external reference
RFVSG(-X)	<b>Option AIQ*</b>	External analog IQ inputs (per channel)
RFVSG	<b>Option EB</b>	External power bank adapter cable
RFVSG	<b>Option BAG</b>	Portable Bag
RFVSG(-X)	<b>Option WE</b>	One year warranty extension
RFVSG(-X)	<b>Option ReCal</b>	Recalibration with certificate (recommended: 2 years interval)

\* Option combinations FCP / AIQ and FCP / GPIB not supported.

# GENERAL CHARACTERISTICS

## Remote programming interfaces

- Ethernet 100BaseT LAN interface,
- USB 2.0 device interface
- GPIB (IEEE-488.2,1987) with listen and talk (Option GPIB)
- Control language SCPI Version 1999.0

## Power requirements

Single channel model

Input voltage range	24 VDC $\pm$ 3.0 V	
Power consumption (typ) (without options)	45W 55W 65W	RFVSG04 RFVSG06, RFVSG12 RFVSG20, RFVSG40
Main adapter supplied (without options)	100 - 240 VAC 50/60Hz; 24 VDC and 65W max	RFVSG04, RFVSG06, RFVSG12
	100 - 240 VAC 50/60Hz; 24 VDC and 160 W max	RFVSG20, RFVSG40

Multi-channel model

Input voltage range	100 - 240 VAC 50/60Hz	
Fuse rating	5x20mm, 250 V, 6.3 AT	2-poles, each
Power consumption (max)	200 W	RFVSG4-4

## Environmental (Levels similar to MIL-PRF-28800F Class 3/4)

Environmental stress Samples of this product have been type tested to be robust against the environmental stresses of storage, transportation, and end-use; those stresses to temperature, humidity, shock, vibration, altitude, and power line conditions.

**Operating temperature range:** 0 to 45 °C

**Storage temperature range:** -40 to 70 °C

**Operating and storage altitude** up to 15,000 feet (4600 m)



notice

EMC complies to EMC regulations and directives for emission and immunity to interference (EN 61326-1 Industrial, EN/IEC 61326-2-1).

**Safety** complies to applicable safety regulation IEC/EN 61010-1.

This product complies with directive 2011/65/EU.

## Single-channel (portable / benchtop)

**Weight:** 2.72 kg (6 lbs) net,  $\leq$  3.63 kg (8 lbs) shipping

**Dimensions:** 124 mm H x 182 mm W x 305 mm L (incl. connectors) [4.21 in H x 6.77 in W x 11.42 in L]

## Multi-channel (rack-mountable) 19" 2HU enclosure

**Weight:** 18 kg (37 lbs) net,  $\leq$  25 kg (8 lbs) shipping

**Dimensions:**

Body: 88 mm H x 444 mm W x 567mm L [3.5 in H x 17.5 in W x 22.3 in L]

Front panel: 88 mm H x 486.2mm W [3.46 in H x 19.14 in W]

**Recommended calibration cycle:** 24 months



## Document History

Version/Status	Date	Author	Notes
V110	2019-10-28	jk	Update
V111	2020-02-20	yg/jk	Update
V113	2020-03-31	jk	Analog modulations revised, option EIQ added, measurement plots added
V114	2020-04-31	jk	New plots added
V120	2020-11-10	jk	Extended to multi-channel, 12 GHz model
V121	2021-1-10	jk	Power specs refined, data plots added
V122	2021-05-03	rp	Pulse modulation, marker, multi-function in/outputs specs refined
V123	2021-06-01	ee	Updated product images
V124	2021-06-25	jk	Refined power ranges
V125	2021-07-20	rp	Updated FCP/Baseband Generator
V126	2022-02-04	jk	Plot update

### AnaPico of Switzerland

Europa-Strasse 9  
8152 Glattbrugg  
Switzerland

Phone +41 44 440 00 50  
Email sales@anapico.com

www.anapico.com  
www.anapico.com/downloads/

