

# Keysight N77xx Series

Getting Started  
Guide

NOTICE: This document contains references to Agilent Technologies. Agilent's former Test and Measurement business has become Keysight Technologies. For more information, go to [www.keysight.com](http://www.keysight.com).



## Notices

© Keysight Technologies, Inc. 2015

No part of this manual may be reproduced in any form or by any means (including electronic storage and retrieval or translation into a foreign language) without prior agreement and written consent from Keysight Technologies, Inc. as governed by United States and international copyright laws.

### Manual Part Number

N7744-90A01

### Edition

Edition 7.0, March 2015

Keysight Technologies,  
Deutschland GmbH  
Herrenberger Str. 130  
71034 Böblingen, Germany

### For Assistance and Support

<http://www.keysight.com/find/assist>

### Limitation of Warranty

The foregoing warranty shall not apply to defects resulting from improper or inadequate maintenance by Buyer, Buyer-supplied software or interfacing, unauthorized modification or misuse, operation outside of the environmental specifications for the product, or improper site preparation or maintenance. No other warranty is expressed or implied. Keysight Technologies specifically disclaims the implied warranties of Merchantability and Fitness for a Particular Purpose.

## Warranty

**THE MATERIAL CONTAINED IN THIS DOCUMENT IS PROVIDED “AS IS,” AND IS SUBJECT TO BEING CHANGED, WITHOUT NOTICE, IN FUTURE EDITIONS. FURTHER, TO THE MAXIMUM EXTENT PERMITTED BY APPLICABLE LAW, KEYSIGHT DISCLAIMS ALL WARRANTIES, EITHER EXPRESS OR IMPLIED, WITH REGARD TO THIS MANUAL AND ANY INFORMATION CONTAINED HEREIN, INCLUDING BUT NOT LIMITED TO THE IMPLIED WARRANTIES OF MERCHANTABILITY AND FITNESS FOR A PARTICULAR PURPOSE. KEYSIGHT SHALL NOT BE LIABLE FOR ERRORS OR FOR INCIDENTAL OR CONSEQUENTIAL DAMAGES IN CONNECTION WITH THE FURNISHING, USE, OR PERFORMANCE OF THIS DOCUMENT OR OF ANY INFORMATION CONTAINED HEREIN. SHOULD KEYSIGHT AND THE USER HAVE A SEPARATE WRITTEN AGREEMENT WITH WARRANTY TERMS COVERING THE MATERIAL IN THIS DOCUMENT THAT CONFLICT WITH THESE TERMS, THE WARRANTY TERMS IN THE SEPARATE AGREEMENT SHALL CONTROL.**

### Technology Licenses

The hardware and/or software described in this document are furnished under a license and may be used or copied only in accordance with the terms of such license.

### Restricted Rights Legend

If software is for use in the performance of a U.S. Government prime contract or subcontract, Software is delivered and licensed as “Commercial computer software” as defined in DFAR 252.227-7014 (June 1995), or as a “commercial item” as defined in FAR 2.101(a) or as “Restricted computer software” as

defined in FAR 52.227-19 (June 1987) or any equivalent agency regulation or contract clause. Use, duplication or disclosure of Software is subject to Keysight Technologies’ standard commercial license terms, and non-DOD Departments and Agencies of the U.S. Government will receive no greater than Restricted Rights as defined in FAR 52.227-19(c)(1-2) (June 1987). U.S. Government users will receive no greater than Limited Rights as defined in FAR 52.227-14 (June 1987) or DFAR 252.227-7015 (b)(2) (November 1995), as applicable in any technical data.

## Safety Notices

### CAUTION

A **CAUTION** notice denotes a hazard. It calls attention to an operating procedure, practice, or the like that, if not correctly performed or adhered to, could result in damage to the product or loss of important data. Do not proceed beyond a **CAUTION** notice until the indicated conditions are fully understood and met.

### WARNING

A **WARNING** notice denotes a hazard. It calls attention to an operating procedure, practice, or the like that, if not correctly performed or adhered to, could result in personal injury or death. Do not proceed beyond a **WARNING** notice until the indicated conditions are fully understood and met.

# Contents

## 1 Getting Started

Keysight N7744A and N7745A Optical Power Meter	7
Keysight N7747A and N7748A Optical Power Meter	8
Keysight N775xA Optical Attenuator and Power Meter and N776xA Optical Attenuator	8
Keysight N7711/4A Single and 4-Port Tunable Laser System Source	9
Keysight N773x Optical Switch	10
Initial Inspection	11
Claims and Repackaging	11
Return Shipments to Keysight Technologies	12
Safety Considerations	13
Safety Considerations - Overview	13
Safety Symbols	13
General	14
Operating Environment	15
Line Power Requirements	15
Initial Safety Information for Tunable Laser Modules	15
Laser Safety Labels	16
Input/Output Signals	17
Line Power Connectors	17
Instrument Markings	18
AC Line Power Supply Requirements	19
AC Line Power Supply Requirements - Overview	19
Line Power Requirements	19
Line Power Cable	19
Changing the Fuse	21

<b>Operating and Storage Environment</b>	<b>21</b>
<b>Operating and Storage Environment - Overview</b>	<b>21</b>
Temperature	21
Humidity	22
Altitude	22
Pollution Protection	22
Instrument Cooling	22
<b>Input and Output Connectors</b>	<b>23</b>
<b>Input and Output Connectors - Overview</b>	<b>23</b>
<b>Front Panels - Multiport Power Meters</b>	<b>24</b>
<b>Front Panels - Optical Attenuators</b>	<b>25 Front</b>
<b>Panels - Tunable Laser Source</b>	<b>26 Front</b>
<b>Panels - Optical Switches</b>	<b>27</b>
Rear Panel	27
<b>Making Optical Connections</b>	<b>28</b>
<b>Making Optical Connections</b>	<b>28</b>
<b>Making Quad-adapter Connections on the Keysight N7744/45A Multiport Power Meter</b>	<b>30</b>
<b>Optical Output</b>	<b>31</b>
<b>Electrical Connectors</b>	<b>32</b>
<b>LAN Interface</b>	<b>33</b>
LAN Interface	33
Selecting a LAN Network	33
Private LAN Considerations	33
Security	33
Performance	34
Reliability	34
IP Address Availability	34 Site
LAN Considerations	34
Connecting the LAN Cable	35
<b>GPIB Interface</b>	<b>37</b>
GPIB Interface	37
Cables and Adapters	37
Connector	38
GPIB Logic Levels	38
<b>USB Interface</b>	<b>39</b>
<b>Powering Up the Instrument</b>	<b>39</b>
Powering Up the Instrument	39
Front Panel Indicators	40

<b>Connecting to the Instrument</b>	<b>40</b>
<b>Connecting to the Instrument - Overview</b>	<b>40</b>
<b>Connecting over USB</b>	<b>40</b>
<b>Finding the IP Address of an instrument</b>	<b>42</b>
<b>Connecting over LAN</b>	<b>43</b>
<b>N77xx Viewer Common User Interface Functions</b>	<b>47</b>
<b>Software Installation</b>	<b>47</b>
<b>Connecting to an Instrument</b>	<b>47</b>
<b>Viewing Measurements and Settings</b>	<b>50</b>
<b>Saving and Recalling Configurations</b>	<b>51</b>
<b>Controlling the Instrument Refresh</b>	<b>52</b>

<b>Index</b>	<b>53</b>
--------------	-----------



# 1

## Getting Started

### Keysight N7744A and N7745A Optical Power Meter

The Keysight N7744A and Keysight N7745A are LXI compliant optical power meters with 4 or 8 power-sensor ports respectively. They address productivity challenges by increasing throughput and operational efficiency using industry-leading device connectivity, high-speed acquisition of measurement data and fast data transfer for post-processing.

The Keysight N7744A and Keysight N7745A are designed to characterize optical multiport components, such as multiplexers, PON splitters, wavelength selective switches (WSS) and ROADMs, in all product phases from R&D to manufacturing.

The one rack unit (1U half-rack high) instrument can be operated alone or with other units, by PC connected over LAN, USB, or GPIB.

The unprecedented N7740A fiber connectivity concept consists of a quadruple adapter (quad-adapter) with a quick-locking mechanism. Up to four fiber connectors from the device under test (DUT) can be connected in a comfortable working position to one quad-adapter. The push-on locking mechanism makes it easy and secure to attach the quad-adapter to and remove the quad-adapter from the instrument in seconds. With multiple quad-adapters, the measurement task can be fully separated from the DUT connection task. This means a further increase in test throughput. Where this is not an issue, traditional single connector connectivity is supported as well.

These power meters are highly compatible with setups and programs developed using the Keysight 816x modular power meters. They are also easy to synchronize with Keysight tunable laser sources, to make spectral measurements. The functionality for time-dependent measurement has been extended with sampling at up to 1 MHz and data logging of up to 1 million samples for each port.



## Keysight N7747A and N7748A Optical Power Meter

The two-port N7747A and 4-port N7748A optical power meters bring the highest performance in terms of sensitivity, noise and relative accuracy to the compact N77 instrument platform. These instruments combine the optical performance of the 81634B sensor modules with the large memory, fast data transfer and small footprint of the N77 series platform. Eight high-sensitivity optical power meters now fit in a single rack unit. Optical connections are made with the interchangeable 81000xI connector interface system.

## Keysight N775xA Optical Attenuator and Power Meter and N776xA Optical Attenuator

The Keysight N775xA and N776xA are compact multichannel attenuators and power meters. They are a new class of remote-controlled fiber optic instruments. All attenuators feature power control functionality to set the output power level of the attenuator.

The Keysight N7751A and Keysight N7752A are optical attenuators for single mode fiber with one and two single-mode fiber attenuator channels respectively and two extra optical power meter channels, for convenient power measurements and setup calibration. The Keysight N7761A, Keysight N7762A and Keysight N7764A are single-mode fiber optical attenuators for single mode fiber, with one, two and four attenuator channels respectively.

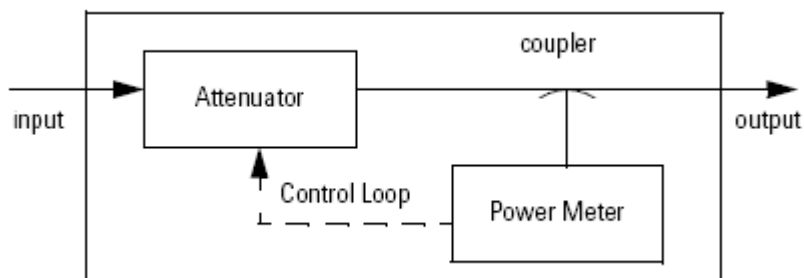
All N775xA and N776xA attenuators address productivity challenges by increasing throughput and operational efficiency.

The Keysight N7766A and the Keysight N7768A are optical attenuators for multimode fibers with two or four attenuator channels respectively. Both multimode attenuators are available with 50 $\mu$ m and 62.5 $\mu$ m multimode fiber.

The N7766A and N7768A are 2 and 4 channel multimode fiber attenuators that are optimized for quick power setting and preservation of the input modal power distribution.

The attenuators are designed to attenuate and control the power of light in optical fibers. They allow you to accurately and repeatably set the attenuation factor or power level manually using the Viewer software, or using the programming interface.

The attenuators include power control functionality that allow you to set the output power level of the attenuator. When power control mode is enabled, the module automatically corrects for power changes at the input so that the output power level you set is maintained.



**Figure 1** Optical Attenuators with Power Control

The one rack unit (1U half-rack high) instrument can be operated alone or with other units, controlled over LAN, USB, or GPIB.

These attenuators and power meters are fully compatible with setups and programs developed using the Keysight 8157x modular attenuators and basic 8163x optical power meter commands, not including logging functionality.

### Modal Fidelity for Multimode Fiber Systems

Signals in multimode fibers are distributed over a range of mode groups that can have different loss and delay in a link. For dependable multimode transceiver testing, the instrument used to set the power level should not change this modal distribution. The bulk-optic filter and collimated beam path of Keysight multimode attenuators are designed to assure homogeneous attenuation of all input modes.

## Keysight N7711/4A Single and 4-Port Tunable Laser System Source

The Keysight N7711A and N7714A tunable lasers are single-port and four-port sources, available with C-band or L-band wavelength coverage. The narrow linewidth and offset grid fine-tuning capability of the N7711A and N7714A make them ideal sources for realistic loading of the latest transmission systems.

To owners of Keysight proven Lightwave Measurement System the 81950A tunable laser source module offers the same features as the N7711A. The 81950A plugs into the 8163B and 8164B mainframes. For additional information about the 81950A please refer to the Compact Tunable Laser data sheet, publication no. 5988-8518EN.

All models can reach any wavelength point within their specified wavelength range just like all other Keysight tunable lasers. In this mode,

code compatibility with existing test setups based on Keysight's range of full-size and compact tunable lasers is a great asset. In system loading applications, it may be preferable to grid-tune the lasers like system transmitters, simply by changing the channel index. The channel grid is adjustable to standard ITU-T grid spacing like 50 GHz, and to arbitrary grids. Likewise, the zero frequency (base channel) of the chosen grid is adjustable. A 12 GHz fine-tuning range allows de-tuning the frequency.

Targeted for high test throughput, lowest cost-per-channel, and narrow footprint, all members of Keysight's 77-Series optical test instruments are built on a common platform and a common PC-based user interface. A complete set of control interfaces including LAN, USB2.0 and GPIB simplifies integration with manufacturing control systems. Code compatible to Keysight's Lightwave Measurement System modules, the new instrument generation can serve as plug-in replacements in existing test solutions. The N77 viewer software allows to control all features of the N7711/4A tunable laser sources.

## Keysight N773x Optical Switch

The Keysight N77-Series optical switches are available for both single-mode and multimode fiber test applications. The excellent repeatability, compact format and flexible control interfacing support high-performance automated setups. The multimode switch has excellent mode fidelity.

These instruments are used for automatic routing of optical signals for testing devices like transceivers, amplifiers, and passive components. Optical switches optimize the investment in automated test equipment by improving repeatability and throughput and supporting parallel measurements of multiport and multiple devices.

These switches can be used to avoid repeated reconnections during your measurements and are critical to automated procedures. The excellent switching repeatability assures that the signal level is constant from cycle to cycle. The low IL and PDL and high repeatability assure minimum impact of the switch on measurement accuracy. A typical setup may use a 1x4 switch to select among several source wavelengths in a test, while avoiding the time delay for power stabilization if each source must be cycled on and off. Or the same digital signal may be switch among several instruments, like a power meter, DCA or BERT.

In many cases, valuable signal source and analysis instrumentation can be used more effectively in a parallel-test configuration. For example, multiple cables or components can be tested together during temperature cycling. On the other hand, an increasing use of inherently parallel components, as for optical interconnections for 40G or 100G using 10 Gb/s components, calls for identical testing in multiple paths.

These are well supported by the 1x13 switch configuration and the 13th path can often be used as a permanent reference path.

Signals in multimode fibers are distributed over a range of mode groups that can have different loss and delay in a link. For dependable multimode transceiver testing, the instrument used to set the power level should not change this modal distribution. The Keysight multimode switches are designed with very short collimated paths between fiber, so signals propagate in practically the same distribution as through uninterrupted multimode fiber.

## Initial Inspection

Inspect the shipping container for damage. If there is damage to the container or cushioning, keep them until you have checked the contents of the shipment for completeness and verified the instrument both mechanically and electrically. The Function Tests give a procedure for checking the operation of the instrument. If the contents are incomplete, mechanical damage or defect is apparent, or if an instrument does not pass the operator's checks, notify the nearest Keysight Technologies Sales/Service Office.

**NOTE**

To avoid hazardous electrical shock, do not perform electrical tests when there are signs of shipping damage to any portion of the outer enclosure (covers, panels, and so on).

---

## Claims and Repackaging

If physical damage is evident or if the instrument does not meet specification when received, notify the carrier and the nearest Keysight Technologies Sales/Service Office. The Keysight Technologies Sales/Service Office will arrange for repair or replacement of the unit without waiting for settlement of the claim against the carrier.

## Return Shipments to Keysight Technologies

If the instrument is to be shipped to an Keysight Technologies Sales/Service Office, attach a tag showing owner, return address, model number and full serial number and the type of service required.

The original shipping carton and packing material may be reusable, but the Keysight Technologies Sales/Service Office will provide information and recommendations on materials to be used if the original packing is no longer available or reusable. General instructions for repackaging are as follows:

- Wrap instrument in heavy paper or plastic.
- Use strong shipping container. A double wall carton made of 350-pound test material is adequate.
- Use enough shock absorbing material (3 to 4 inch layer) around all sides of the instrument to provide a firm cushion and prevent movement inside container. Protect control panel with cardboard.
- Seal shipping container securely.
- Mark shipping container FRAGILE to encourage careful handling.
- In any correspondence, refer to instrument by model number and serial number.

### Deleting user data

If you need to delete all your logged data and user configurations, that is to reset the instrument completely:

- 1 Press and hold the Reset/standby button until the instrument starts to reboot.
- 2 When the instrument reboots, press the Reset/standby button once more briefly, to confirm you want to delete all the stored data.

# Safety Considerations

## Safety Considerations - Overview

The following general safety precautions must be observed during all phases of operation, service, and repair of this instrument. Failure to comply with these precautions or with specific warnings elsewhere in this manual violates safety standards of design, manufacture, and intended use of the instrument. Keysight Technologies Inc. assumes no liability for the customer's failure to comply with these requirements. This product has been designed and tested in accordance with IEC Publication 61010-1, Safety Requirements for Electrical Equipment for Measurement, Control and Laboratory, and has been supplied in a safe condition. The instruction documentation contains information and warnings that must be followed by the user to ensure safe operation and to maintain the product in a safe condition.

## Safety Symbols

### CAUTION

The *caution* sign denotes a hazard. It calls attention to a procedure which, if not correctly performed or adhered to, could result in damage to or destruction of the product. Do not proceed beyond a caution sign until the indicated conditions are fully understood and met.

---

### WARNING

The *warning* sign denotes a hazard. It calls attention to a procedure which, if not correctly performed or adhered to, could result in injury or loss of life. Do not proceed beyond a warning sign until the indicated conditions are fully understood and met.

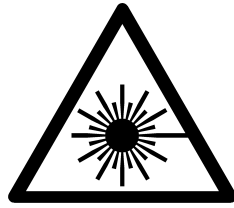
---



The apparatus will be marked with this symbol when it is necessary for the user to refer to the instruction manual in order to protect the apparatus against damage.

---

## 1 Getting Started



Hazardous laser radiation.



Invisible laser radiation.

### General

This is a Safety Class 1 instrument (provided with a protective earth terminal) and has been manufactured and tested according to international safety standards.

Before operation, you should review the instrument and manual for safety markings and instructions. You must follow these to ensure safe operation and to maintain the instrument in safe condition.

Some circuits are powered whenever the instrument is connected to the AC power source. To disconnect from the line power, disconnect the power cord either at the rear power inlet or at the AC line power source (receptacle). One of these must always be accessible. If the instrument is in a cabinet, it must be disconnected from the line power by the system's line power switch.

#### **WARNING**

**To avoid hazardous electrical shock, do not perform electrical tests when there are signs of shipping damage to any portion of the outer enclosure (covers, panels, and so on).**

## Operating Environment

### WARNING

The instrument is not designed for outdoor use. To prevent potential fire or shock hazard, do not expose the instrument to rain or other excessive moisture.

## Line Power Requirements

### CAUTION

The instrument complies with installation category II and can operate from the single-phase AC power source that supplies between 100 V and 240 V at a frequency in the range 50 to 60 Hz. The maximum voltage fluctuation is 10% of the nominal supply voltage. The maximum power consumption is 60 VA with all options installed.

## Initial Safety Information for Tunable Laser Modules

The laser sources specified by this user guide are classified according to IEC 60825-1 (2007).

The laser sources comply with 21 CFR 1040.10 except for deviations pursuant to Laser Notice No. 50 dated 2007-June-24.

**Table 2**

	<b>Keysight N7711A, N7714A</b>	<b>Keysight N7711A, N7714A</b>
	<b>Options 210, 222, 240</b>	<b>Options 201, 222, 204</b>
Laser Type	ECL-Laser InGaAsP	ECL-Laser InGaAsP
Wavelength range	1527nm-1566nm	1570nm-1609nm
Max. CW output power*	50 mW	50 mW
Beam waist diameter	9 $\mu$ m	9 $\mu$ m



**Table 2**

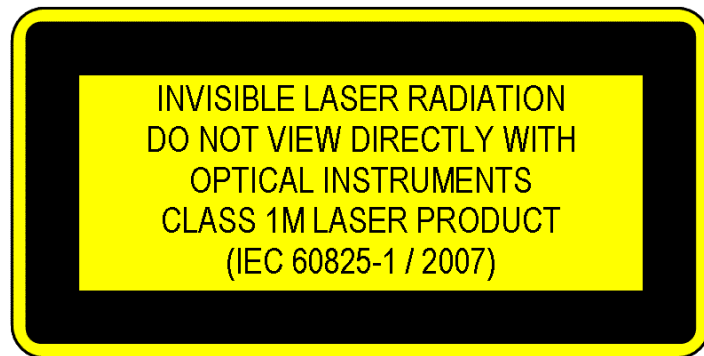
	<b>Keysight N7711A, N7714A</b>	<b>Keysight N7711A, N7714A</b>
	<b>Options 210, 222, 240</b>	<b>Options 201, 222, 204</b>
Numerical aperture	0.1	0.1
Laser Class according to IEC 60825-1 (2007)	1 M	1 M
Max. permissible CW output power**	163 mW	163 mW

*\* Max. CW output power is defined as the highest possible optical power that the laser source can produce at its output connector.*

*\*\* Max. permissible CW output power is the highest optical power that is permitted within the appropriate laser class.*

## Laser Safety Labels

### Laser class 1M label



**Figure 2** Class 1M Safety Label - N7711/14A, N7721/22A

A sheet of laser safety labels is included with the laser module as required. In order to meet the requirements of IEC 60825-1 we recommend that you stick the laser safety labels, in your language, onto a suitable location on the outside of the instrument where they are clearly visible to anyone using the instrument.

**WARNING**

Please pay attention to the following laser safety warning: Under no circumstances look into the end of an optical cable attached to the optical output when the device is operational. The laser radiation can seriously damage your eyesight. Do not enable the laser when there is no fiber attached to the optical output connector. The laser is enabled by pressing the 'active' button close to the optical output connector on the front panel of the module. The laser is on when the green LED on the front panel of the instrument is lit. The use of optical instruments with this product will increase eye hazard. The laser module has a built-in safety circuitry which will disable the optical output in the case of a fault condition Refer servicing only to qualified and authorized personnel.

---

## Input/Output Signals

**CAUTION**

There is one input BNC connector: Trigger In. This is a TTL input.

A maximum of 5 V can be applied as an external voltage to this input connector.

There is one output BNC connector: Trigger Out. This is a TTL output. Do not apply an external voltage to this connector.

The N7747A and N7748A have front-panel BNC connectors for each optical port. This is an analog voltage output (0 to 2V). Do not apply an external voltage to this connector.

---

## Line Power Connectors

In accordance with international safety standards, the instrument has a three-wire power cable. When connected to an appropriate AC power receptacle, this cable earths the instrument cabinet. The type of power cable shipped with each instrument depends on the country of destination. Please refer to "Accessories" section in the User's Guide for the part numbers of available power cables.

### WARNING

To avoid the possibility of injury or death, you must observe the following precautions before switching on the instrument.

- Insert the power cable plug only into a socket outlet provided with a protective earth contact. Do not negate this protective action by the using an extension cord without a protective conductor.
- Do not interrupt the protective earth connection intentionally.
- Do not remove protective covers. Operating personnel must not remove instrument covers. Component replacement and internal adjustments must be made only by qualified service personnel.
- Instruments that appear damaged or defective should be made inoperative and secured against unintended operation until they can be repaired by qualified service personnel.
- Defective, damaged, or malfunctioning laser sources must be returned to an Keysight Technologies Service Center.

Do not operate the instrument in the presence of flammable gases or fumes. Operation of any electrical instrument in such an environment constitutes a definite safety hazard.

---

## Instrument Markings



The instruction manual symbol. The product is marked with this warning symbol when it is necessary for the user to refer to the instructions in the manual.



The CE mark is a registered trademark of the European Community.



The CSA mark is a registered trademark of the Canadian Standards Association.



The C-Tick mark is a registered trademark of the Australian Spectrum Management Agency.

---



The recycling symbol indicates the general ease with which the instrument can be recycled.



Do not dispose in domestic household waste. To return unwanted products, contact your local Keysight office, or see for more information.

## AC Line Power Supply Requirements

### AC Line Power Supply Requirements - Overview

This section provides information on:

- Line Power Requirements
- Line Power Cable
- Changing the Fuse

### Line Power Requirements

The instrument complies with installation category II and can operate from the single-phase AC power source that supplies between 100 V and 240 V at a frequency in the range 50 to 60 Hz. The maximum voltage fluctuation is 10% of the nominal supply voltage. The maximum power consumption is 60 VA with all options installed.

### Line Power Cable

In accordance with international safety standards, the instrument has a three-wire power cable. When connected to an appropriate AC power receptacle, this cable earths the instrument cabinet. For the part number of the power cable for your country and instrument, see .

## 1 Getting Started

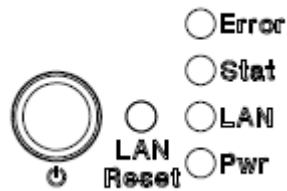
### CAUTION

Please note that the switch on the front panel of the instrument does not stop the flow of power to the instrument.

If you need to turn off the power, unplug the instrument at the mains or remove the power cable connector from the appliance coupler at the rear of the instrument. For this reason, the power cable connection should be easily accessible - allowing you to turn off the power quickly. If the instrument is in a cabinet, it must be disconnected from the line power by the system's line power switch.

---

The power switch allows you to switch between stand-by mode and power-on mode.



**Figure 3** Power Switch

When the instrument is in stand-by mode, the Pwr LED is orange. When the instrument is powered-on, the Pwr LED is green.

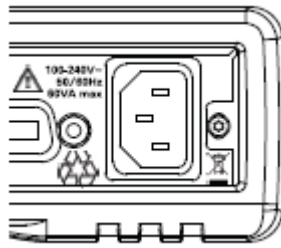
### WARNING

**To avoid the possibility of injury or death, you must observe the following precautions before switching on the instrument.**

- **Insert the power cable plug only into a socket outlet provided with a protective earth contact. Do not negate this protective action by using an extension cord without a protective conductor.**
- **Do not interrupt the protective earth connection intentionally.**

---

The AC power requirements are summarized on the rear panel of the instrument.



**Figure 4** AC Power Requirement Markings

## Changing the Fuse

### CAUTION

There is no user replaceable fuse for the instrument. Changing the fuse should be carried out only by Keysight Technologies service personnel. If you need to get the fuse replaced refer to your nearest Keysight Technologies Sales/Service Office.

## Operating and Storage Environment

### Operating and Storage Environment - Overview

The following summarizes the operating environment ranges. In order for the instrument to meet specifications, the operating environment must be within these limits.

### WARNING

**The instrument is not designed for outdoor use. To prevent potential fire or shock hazard, do not expose the instrument to rain or other excessive moisture.**

### Temperature

The instrument should be protected from temperature extremes and changes in temperature that may cause condensation within it.

The operating temperature is from 5°C to +40°C.

The storage temperature is from -40°C to +70°C.

### **Humidity**

The operating humidity is 15 to 95%, non-condensing.

### **Altitude**

The maximum operating altitude is 2000 m.

### **Pollution Protection**

The instruments are designed for pollution degree 2.

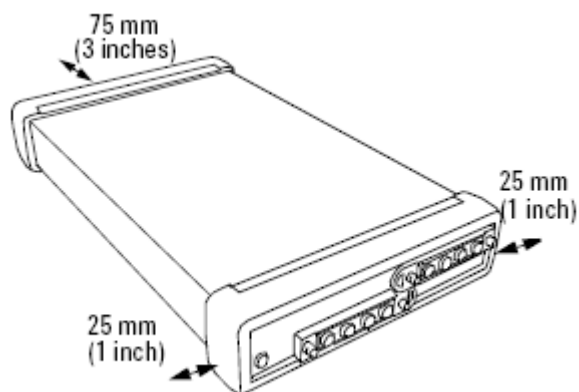
### **Instrument Cooling**

The instrument has a cooling fan mounted internally.

Mount or position your instrument upright and horizontally, as shown in Figure 4 so that air can circulate through it freely.

### **Operating Position**

When operating the instrument choose a location that provides at least 75 mm (3 inches) of clearance at the rear, and at least 25 mm (1 inch) of clearance at each side. Failure to provide adequate air clearance may result in excessive internal temperature, reducing instrument reliability. The instrument should not be operated when resting on its rear or side panels.



**Figure 5** Correct Operating Position

(shown here for the Keysight N7744/5A, valid also for the N7747/48A, N7751/2A, Keysight N7761/2/4A, N7766/68A, N773xA and the N7711/4A)

## Input and Output Connectors

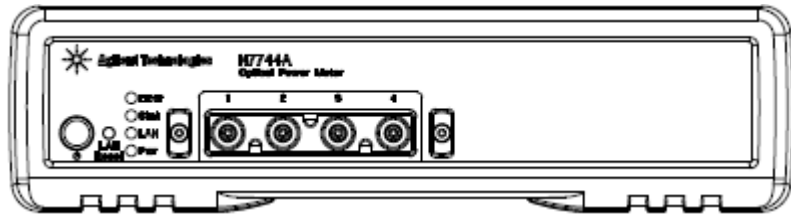
### Input and Output Connectors - Overview

This section provides information on:

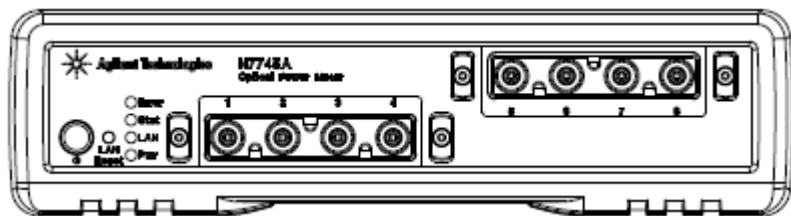
- Front Panels - Multiport Power Meters
- Front Panels - Optical Attenuators
- Front Panels - Tunable Laser Source
- Front Panels - Optical Switches
- Rear Panel



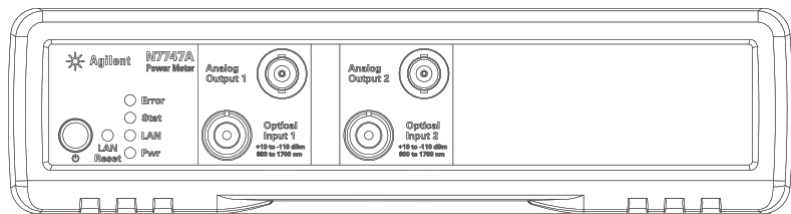
## Front Panels - Multiport Power Meters



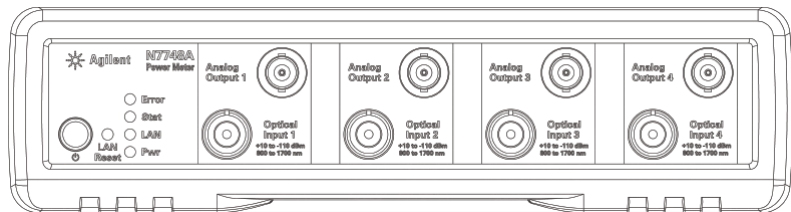
**Figure 6** Front panel of the Keysight N7744A 4-Channel Optical Multiport Power Meter



**Figure 7** Front panel of the Keysight N7745A 8-Channel Optical Multiport Power Meter

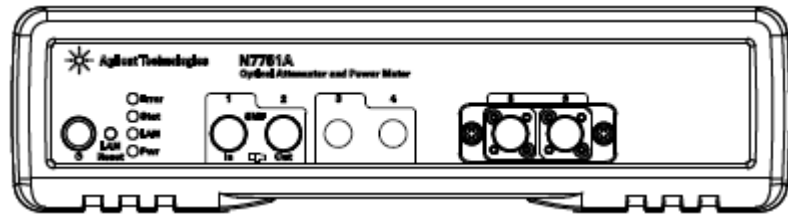


**Figure 8** Front panel of the Keysight N7747A 2-Channel Optical Power Meter

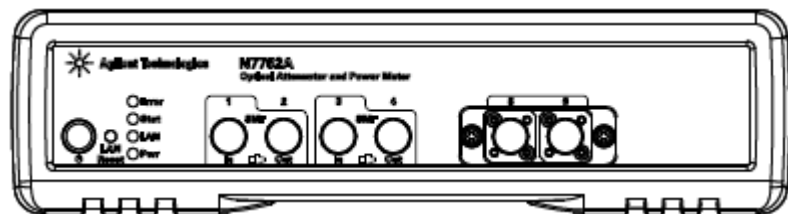


**Figure 9** Front panel of the Keysight N7748A 4-Channel Optical Power Meter

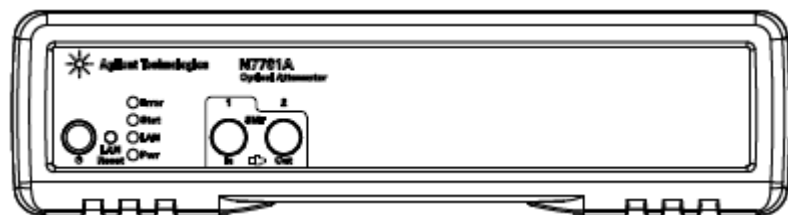
## Front Panels - Optical Attenuators



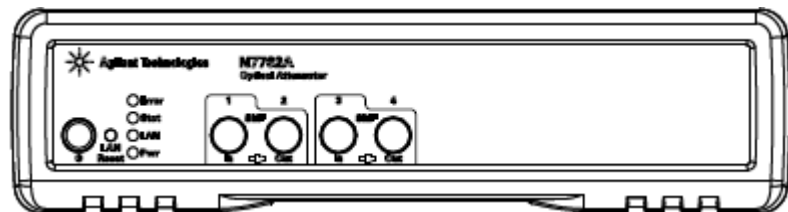
**Figure 10** Front panel of the Keysight N7751A 1-Channel Optical Attenuator and 2-Channel Power Meter



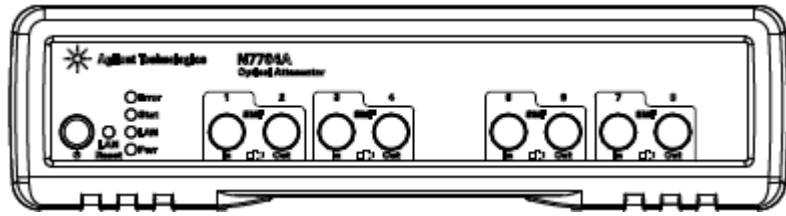
**Figure 11** Front panel of the Keysight N7752A 2-Channel Optical Attenuator and 2-Channel Power Meter



**Figure 12** Front panel of the Keysight N7761A 1-Channel Optical Attenuator

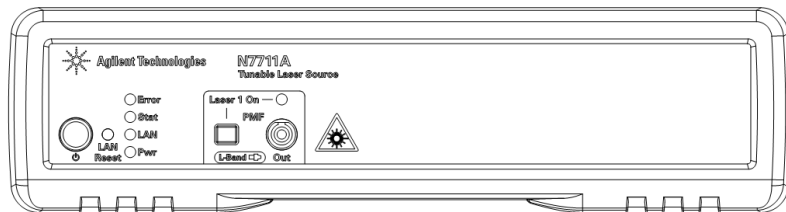


**Figure 13** Front panel of the Keysight N7762A and N7766A 2-Channel Optical Attenuator

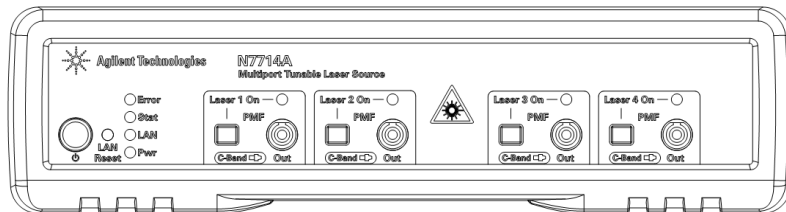


**Figure 14** Front panel of the Keysight N7764A and N7768A 4-Channel Optical Attenuator

## Front Panels - Tunable Laser Source



**Figure 15** Front panel of the Keysight N7711A Single-Port Tunable Laser System Source



**Figure 16** Front panel of the Keysight N7714A Single-Port Tunable Laser System Source

## Front Panels - Optical Switches

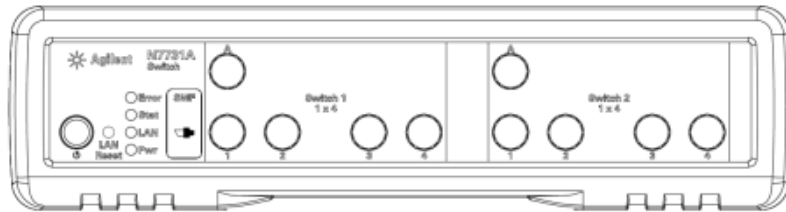


Figure 17 Front panel of the Keysight N7731A 2-Channel 1x4 Optical Switch

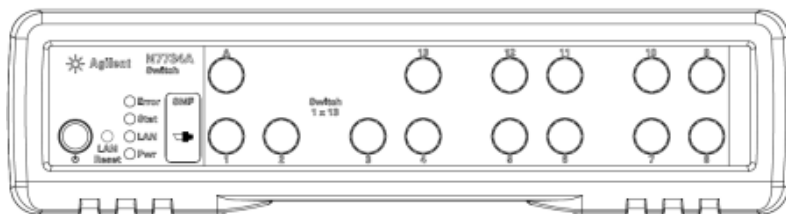


Figure 18 Front panel of the Keysight N7734A 1-Channel 1x13 Optical Switch

## Rear Panel

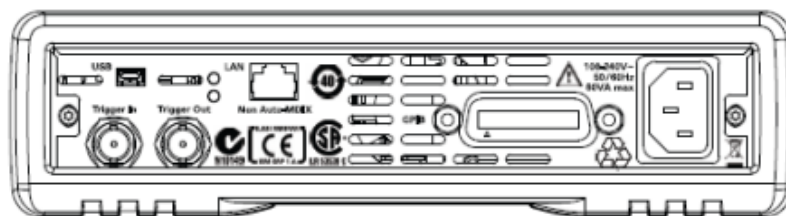


Figure 19 Rear panel of the Keysight N77xx Series instruments

## Making Optical Connections

### Making Optical Connections

The optical attenuators are designed for use with FC connectors.

Attenuators ordered with option 021 have straight connector interfaces.

Attenuators ordered with option 022 have angled connector interfaces.

The option 009 single-mode fiber optical switches have angled FC/APC connectors with narrow keying.

The tunable lasers are designed for use with FC connectors.

Lasers ordered with option 071 have straight connector interfaces.

Lasers ordered with option 072 have angled connector interfaces.

The N7751/2A power meter ports also use FC connectors but are non-contact. They can be used with both angled and straight connectors.

The N7766A and N7768A multimode attenuators have straight connector interfaces. The fiber option determines the dimensions of the internal fiber core, such as 50 or 62.5 $\mu\text{m}$ . Best performance is achieved by matching this to the fibers used in the setup.

The option 062 multimode switches have straight FC/PC connector interfaces. The dimensions of the internal fiber core is 62.5  $\mu\text{m}$ . The switches may also be used with good results together with 50  $\mu\text{m}$  core fiber because the fiber path is short.

#### CAUTION

If the connectors on your attenuator or lasers are angled, you can only use cables with angled connectors with the instrument.

If the connectors on your attenuator are straight, you can only use cables with straight connectors with the instrument.



**Figure 20** Angled and Straight Connector Symbols

The above figure shows the symbols that tell you whether the optical connectors of your instrument are angled or straight. The angled contact connector symbol is colored green.

You should connect straight contact fiber end connectors with neutral sleeves to straight contact connectors, or connect angled contact fiber end connectors with green sleeves to angled contact connectors.

**NOTE**

You cannot connect angled non-contact fiber end connectors with orange sleeves directly to the attenuator or laser.

---

The N774xA power meters do not make contact to the fiber connector faces and can be used with either angled or straight connectors. The N7744A and N7745A use the quad-adapters described below. The N7747A and N7748A use the interchangeable 81000xI connector interfaces, selected for the desired connector type. Common choices are the 81000FI for FC connectors, 81000KI for SC connectors, and 81002LI for LC connectors. The 81000BI can be used for bare fiber connections.

**CAUTION**

When using bare fiber connections to power meters, the length of fiber extending from the fiber holder must be carefully adjusted to avoid scratching the power meter optics.

---

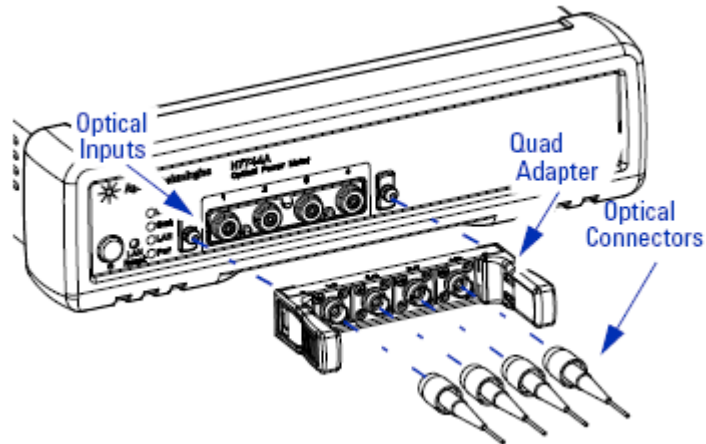
**NOTE**

Connector ferrules with conical or raised-end faces also add positioning uncertainty and are not recommended for use with the N7747A or N7748A.

---

For further details on connector interfaces and accessories, refer to the "Accessories" section in the User's Guide.

## Making Quad-adapter Connections on the Keysight N7744/45A Multiport Power Meter



**Figure 21** Connecting Optical Fibers

**NOTE**

Before you attach a quad-adapter or fiber, you should make sure they are clean. This is important for accurate measurements.

The fibers do not contact the optical inputs (all contact with the optical inputs should be avoided). Usually the only cleaning necessary for the optical inputs is the gentle removal of dust with pressurized, dry air.

For further information, refer to "Maintenance and Troubleshooting" section, described in this manual.

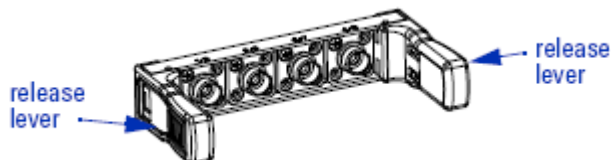
To use a quad-adapter to connect optical fibers to the power meter inputs:

- 1 Select the quad-adapter that suits the optical connector that your optical fiber is terminated with.
- 2 Attach the optical connectors to the quad-adapter. You can attach up to 4 fibers to the quad-adapter at the same time.
- 3 Make sure the number labels on the quad-adapter are at the top.
- 4 Connect the quad-adapter to the optical inputs by pressing it on until it clicks securely into place without pressing the release levers.

## Removing Quad-adapter Interfaces from the Keysight N7744/5A Multiport Power Meter

### NOTE

There are release levers on both sides of the quad-adapter for removing it from the optical inputs.



**Figure 22** Removing Quad-adapter Interfaces

- 1 Press the release levers on both sides of the quad-adapter to release it from the front panel of the power meter.
- 2 You can now remove the optical connectors from the quad-adapter.

### NOTE

Always place the dust cap on unused connector interfaces.

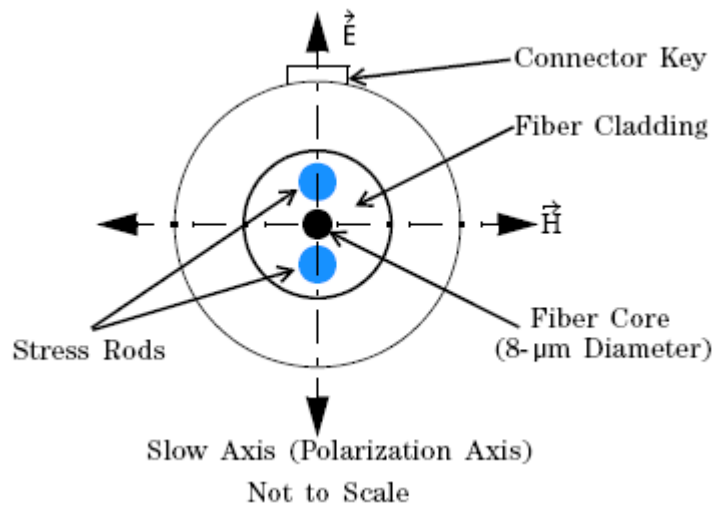
You can use the quad-adapter dust caps to protect the four power meter inputs and the rear of the quad-adapter, for example, when fibers are attached.

## Optical Output

### Polarization Maintaining Fiber

A Polarization maintaining fiber (PMF) output is standard for Keysight N7711/4A tunable laser system sources. PMF is aligned to maintain the state of polarization. A well defined state of polarization helps ensure constant measurement conditions. The fiber is of Panda type, with TE mode in the slow axis in line with the connector key.





**Figure 23** Polarization maintaining fiber

## Electrical Connectors

There are two BNC connectors on the rear panel of your instrument. These are the Trigger Out and the Trigger In connectors.

The N7747A and N7748A have a front panel BNC connector for each channel. These are for analog output signals and provide a voltage proportional to the input signal power in mW. The voltage is in the range 0-2 V and 1 V corresponds to the value of the currently selected power range. For example, when using the -10 dBm range, a 100  $\mu$ W optical power will give 1 V analog output.

### CAUTION

The Trigger In is a TTL input. A maximum of 5 V can be applied as an external voltage to this input connector.

The Trigger Output is a TTL output. Do not apply an external voltage to this connector.

No external voltage should be applied to the analog output connectors of the N7747A and N7748A.

## LAN Interface

### LAN Interface

This section explains the concept of LAN in details.

### Selecting a LAN Network

For the purposes of this guide, a private (isolated) LAN network is defined as a network configuration in which instrument access is a direct connection between the computer and the instrument, or to multiple instruments connected via a *dedicated* router or switch. A site (company-wide) LAN is defined as a network in which instrument access is available to many users at on-site and remote locations. The instrument's application and/or your company's IT (Information Technology) department may have guidelines that help decide the type of network (private or site) used. If a network configuration has not been determined, refer to the following considerations concerning each type.

### Private LAN Considerations

Among the basic parameters of a private LAN network to consider are security, performance, reliability, and IP address availability.

### Security

A private network generally involves a direct connection between the computer and the instrument, or to multiple instruments using switches or routers. Access to the instrument is limited to users on the private network, as opposed to users on a site network that could locate and access the instrument from any location.

Private networks can reduce the possibility of tests being disrupted by unplanned or unauthorized access. Code generation for test systems on a private network is often simplified, as provisions against unauthorized users may not be required.

### **Performance**

Test systems where large amounts of data are transferred usually have faster throughput on a private network. On a site network, heavy and unpredictable LAN traffic affects each instrument (node) on the network. The impact on a test system is that repeatability is difficult to achieve as latencies are difficult to account for.

### **Reliability**

Private networks are fundamentally more reliable than site networks as they host fewer users and are less complex than site networks.

Private networks are isolated from conditions that could bring down (crash) a site network.

### **IP Address Availability**

Every instrument (node) on a LAN (private or site) has an IP (Internet Protocol) address. Due to the expanding use of the internet, the number of site network IP addresses available is limited. By using a router with Dynamic Host Configuration Protocol (DHCP) capability on a private network, the router can assign an IP address to each instrument thus creating a sub-network (subnet) that does not consume site IP addresses.

### **Site LAN Considerations**

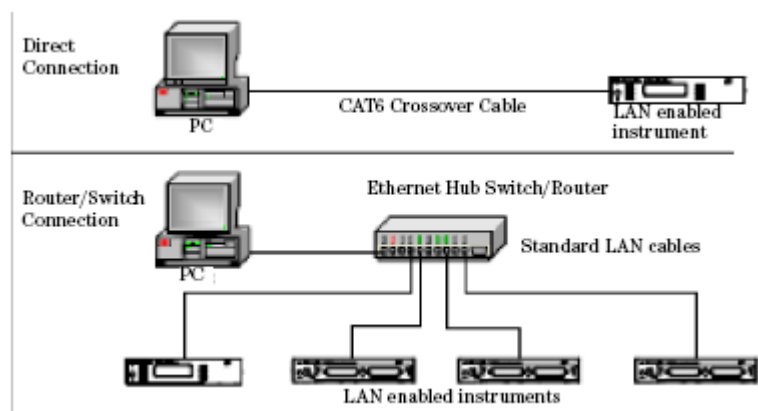
For applications requiring access by many users or by users at distributed sites, a site LAN network is required. In addition to supporting multiple users, site LANs often offer the advantage of being maintained by IT departments. When using a site LAN, consult your IT department regarding LAN configuration and security issues.

## Connecting the LAN Cable

LAN cables are connected between the LAN terminal on the instrument and the computer, or between the instrument and a router or switch if included in your network.

### Private Network Connections

The figure below shows typical LAN cable connections for a private network.



**Figure 24** Typical Private (isolated) LAN Network Connections

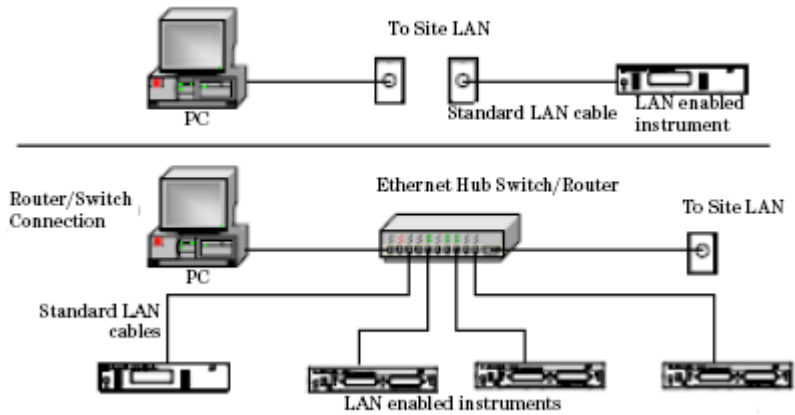
If the instrument is connected directly to the PC, use a LAN crossover cable, as provided with the instrument. If your computer supports Auto-MDIX or contains a LAN card with gigabit data transfer rates, the (blue) crossover cable is not required. A standard LAN cable can be used instead.

For private LAN networks that include a switch or router, use standard LAN cables for all network connections. Do not use a crossover cable.

### Site Network Connections

The following figure shows a typical LAN cable connection for a site network.

# 1 Getting Started



**Figure 25** Typical Site LAN Network Connections.

On site networks, the instrument and the computer are connected directly to site LAN ports, or are connected to the site LAN through a switch. In each site network configuration, standard LAN cables are used.

## The LAN LED

As the LAN connection is made, the DHCP server assigns an address and the LXI device identification proceeds you will see the following indicators;

No LAN link	LAN link No IP Address	LAN link	LXI Device identification
Red LAN	Yellow LAN	Green LAN	Green LAN blink

**Figure 26** The LAN LED

There may be a delay between making the LAN link (yellow status) and getting the IP address (green status). This delay may be longer if there is no DHCP server, for example when the instrument is connected directly to a PC.

### The LAN Reset button

This recessed button has two functions.

- Pressing the button briefly invokes a preset of the instrument and restores default measurement settings. This is equivalent to the programming command

`:SYSTem:PRESet`

- Pressing and holding the button for 3 seconds will reset the LAN parameters to the factory default. This includes changing the password for modifying the configuration via LAN back to the default "Keysight". This is equivalent to the following sequence of programming commands:

`:SYSTem:COMMunicate:ETHernet:RESet`

## GPIB Interface

### GPIB Interface

You can connect your GPIB interface into a star network, a linear network, or a combination star and linear network. The limitations imposed on this network are as follows:

- The total cable length cannot exceed 20 meters.
- The maximum cable length between devices is 4 meters, with an average separation of 2m between devices over the whole bus.
- No more than 15 devices may be interconnected on one bus.

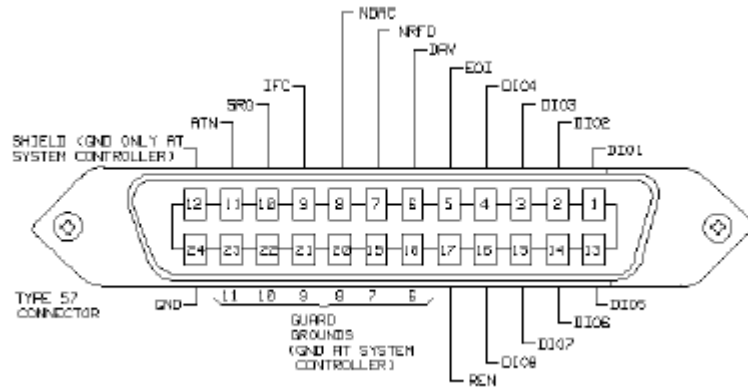
### Cables and Adapters

For further details on cables and adapters, refer to "Cables" section in the User's Guide.

## Connector

The following figure shows the connector and pin assignments.

Connector Part Number: 1251-0293



**Figure 27** GPIB Connector

### CAUTION

Keysight Technologies products delivered now are equipped with connectors having ISO metric-threaded lock screws and stud mounts (ISO M3.5×0.6) that are black in color. Earlier connectors may have lock screws and stud mounts with English-threaded lock screws and stud mounts (6-32 UNC) that have a shiny nickel finish.

### CAUTION

It is recommended that you do not stack more than three connectors, one on top of the other.

Hand-tighten the connector lock screws. Do not use a screwdriver.

## GPIB Logic Levels

The instrument's GPIB lines use standard TTL logic, as follows:

True = Low = digital ground or 0 Vdc to 0.4 Vdc

False = High = open or 2.5 Vdc to 5 Vdc

All GPIB lines have LOW assertion states. High states are held at 3.0 Vdc by pull-ups within the instrument. When a line functions as an input, it requires approximately 3.2 mA to pull it low through a closure to digital

ground. When a line functions as an output, it will sink up to 48 mA in the low state and approximately 0.6 mA in the high state.

**NOTE**

The GPIB line screens are not isolated from ground.

## USB Interface

**NOTE**

Before connecting the instrument over USB, install the Keysight I/O Libraries Suite, which is included on a CD with the instrument.

The instrument is a USB device, with a mini-USB connector.

## Powering Up the Instrument

### Powering Up the Instrument

When you switch on the instrument, the LEDs on the front panel show the various stages of booting.

Standby	Power On	FPGAs loaded	Analog Board 1 loaded	Analog Board 2 loaded
Error	Yellow Error	Green Error	Green Error	Green Error
Stat	Yellow Stat	Yellow Stat	Green Stat	Green Stat
LAN	Yellow LAN	Yellow LAN	Yellow LAN	Green LAN
Yellow Pwr	Green Pwr	Green Pwr	Green Pwr	Green Pwr

**Figure 28** Powering Up the Instrument



## Front Panel Indicators

During operation, you may notice the following LED indicators:

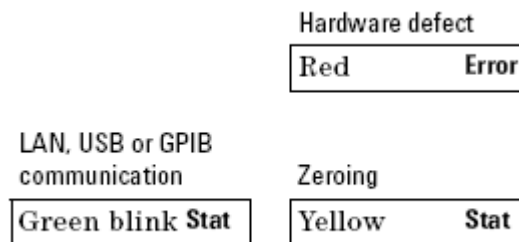


Figure 29 Front Panel Indicators

## Connecting to the Instrument

### Connecting to the Instrument - Overview

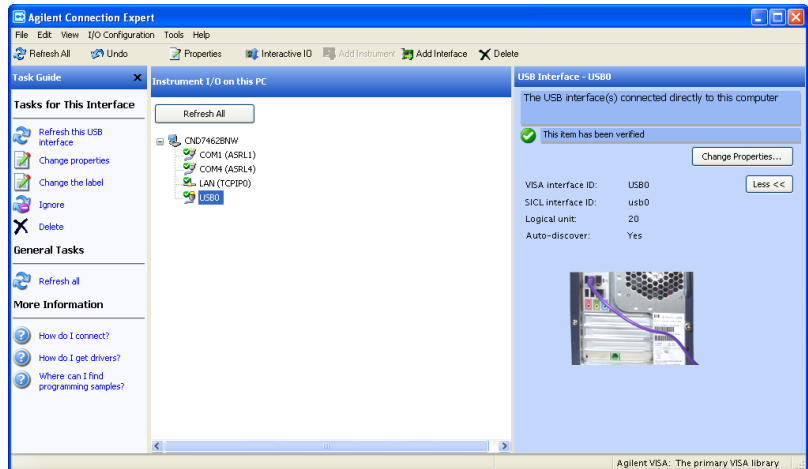
When you are first connecting the instrument, we recommend you use the Keysight Connection Expert included with the Keysight I/O libraries (available on the CD supplied with the instrument, or from [www.Keysight.com](http://www.Keysight.com)).

### Connecting over USB

**NOTE**

The screenshots show the Keysight N7745A Multiport Power Meter. The same procedure applies when connecting an Keysight N7744/7/8A Multiport Power Meter, an Keysight N7751/2A Optical Attenuator and Power Meter, or an Keysight N7761/2/4/6/8A Optical Attenuator or an Keysight N7711/4A Tunable Laser System Source or an N773x Optical Switch.

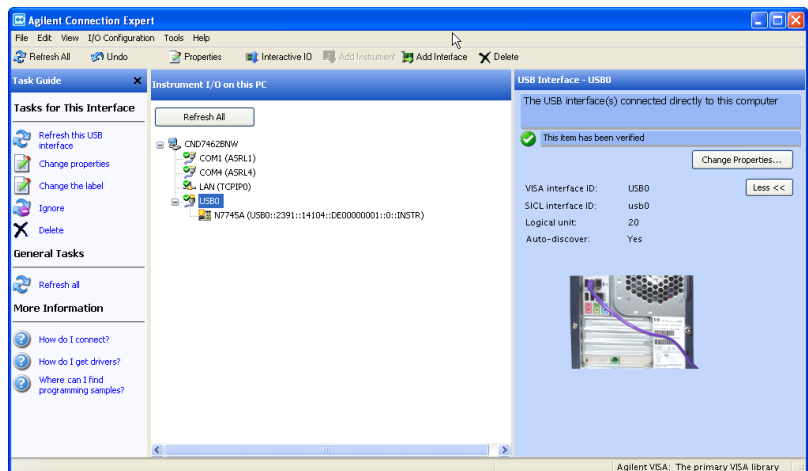
- 1 If it is not already running, start the Keysight Connection Expert software.



**Figure 30** Keysight Connection Expert software

- 2 Attach the instrument to the USB. The first time you attach the instrument, follow the instructions on the screen to select the driver for this instrument.

When the instrument is connected, it is shown in the list.



**Figure 31** Select the instrument in the list

- 3 Select the instrument in the list to see the associated tasks (in the Task Guide on the left) and information (on the right).

# 1 Getting Started

## Finding the IP Address of an instrument

- 1 Connect to the instrument over USB, as described above.
- 2 Select the instrument in the list.

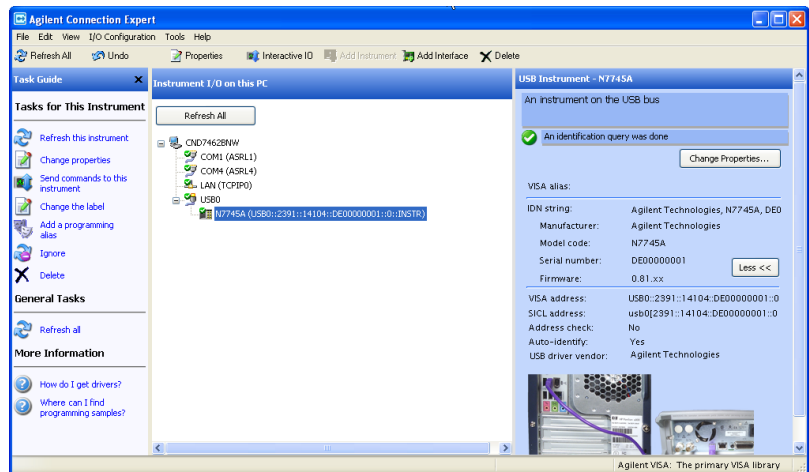


Figure 32 Select the instrument

- 3 Click on “Send commands to this instrument”.
- The default command is the \*IDN? query.

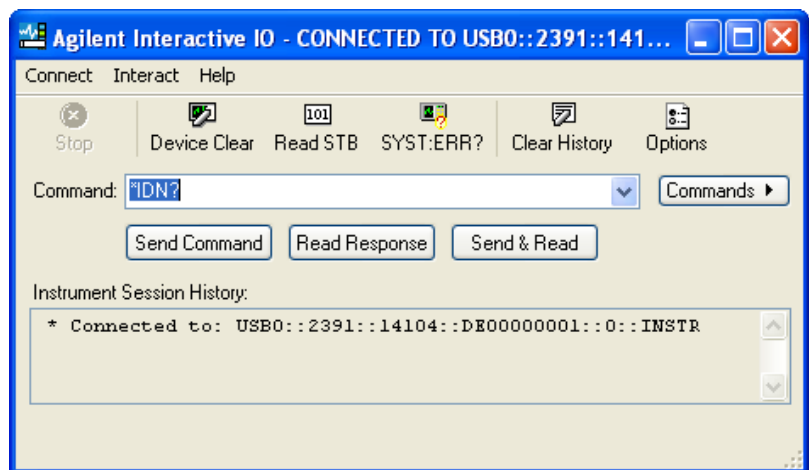
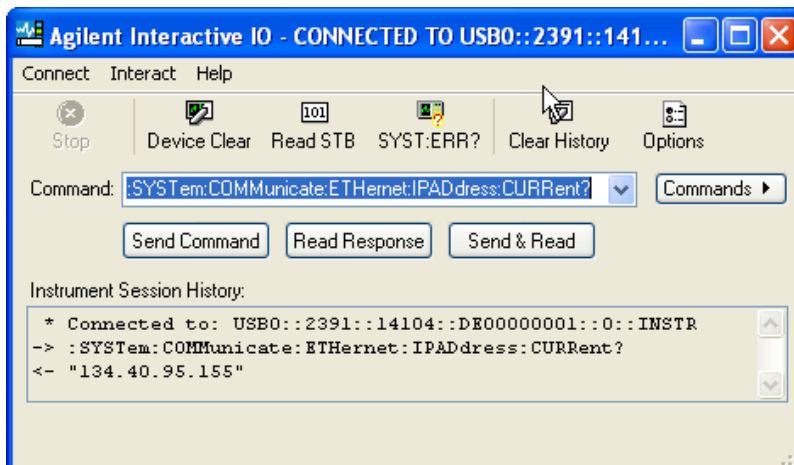


Figure 33 \*IDN? query

- 4 Enter the command  
:SYSTem:COMMunicate:ETHernet:IPAddress:CURRent?

then click on [Send & Read].

The instrument returns its current IP address.



**Figure 34** :SYSTem:COMMunicate:ETHernet:IPADdress:CURRent?

## Connecting over LAN

### NOTE

The screenshots show the Keysight N7745A Multiport Power Meter. The same procedure applies when connecting to other N77xx instruments like attenuators, switches and laser sources.

- 1 Make sure the instrument is connected to the LAN, and that the LAN LED on the front panel is green. See, “[LAN Interface](#)” on [page 33](#) for more information to connecting over LAN.
- 2 If it is not already running, start the Keysight Connection Expert software.
- 3 Select “LAN (TCPIP0)” in the list.

# 1 Getting Started

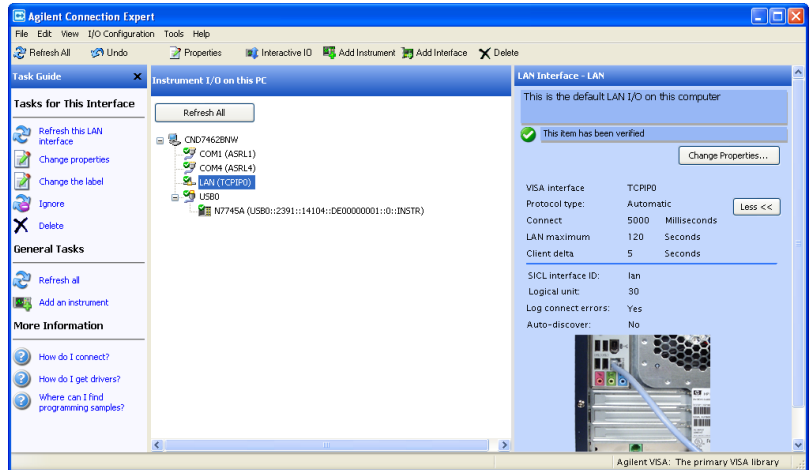


Figure 35

- 4 Click on “Add an instrument” in the Task Guide.
- 5 Wait for the scan to finish.
- 6 Select the instrument in the list.

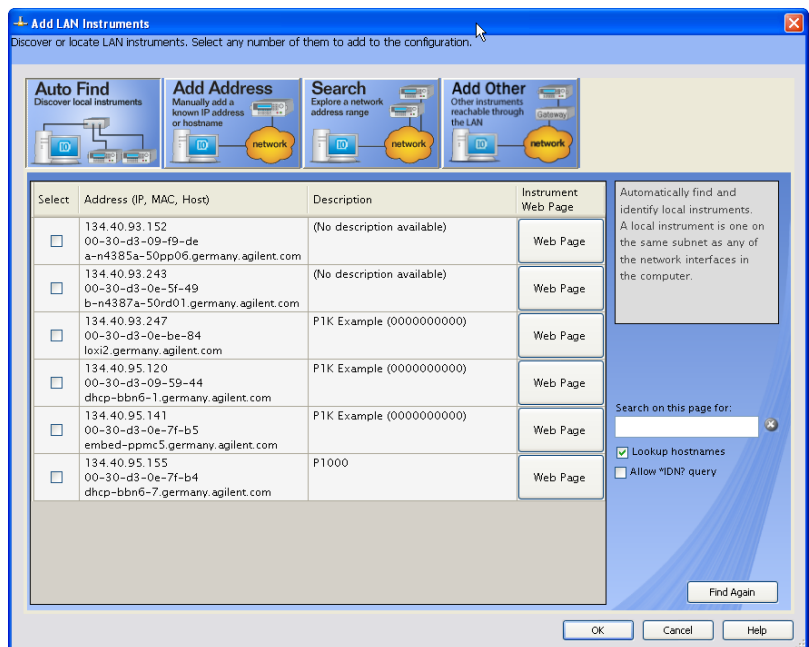


Figure 36

- 7 To show the description of the instrument, check the box for \*IDN? query and click on "Find Again".

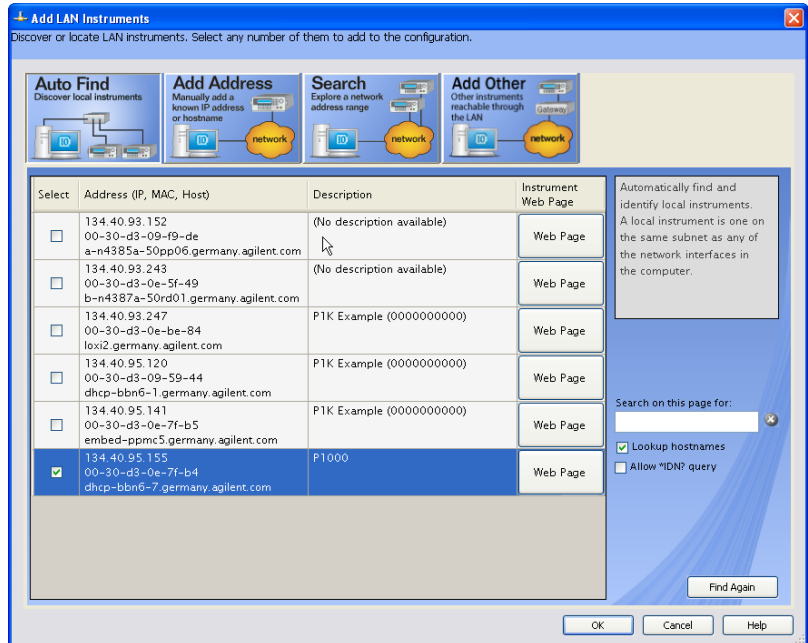
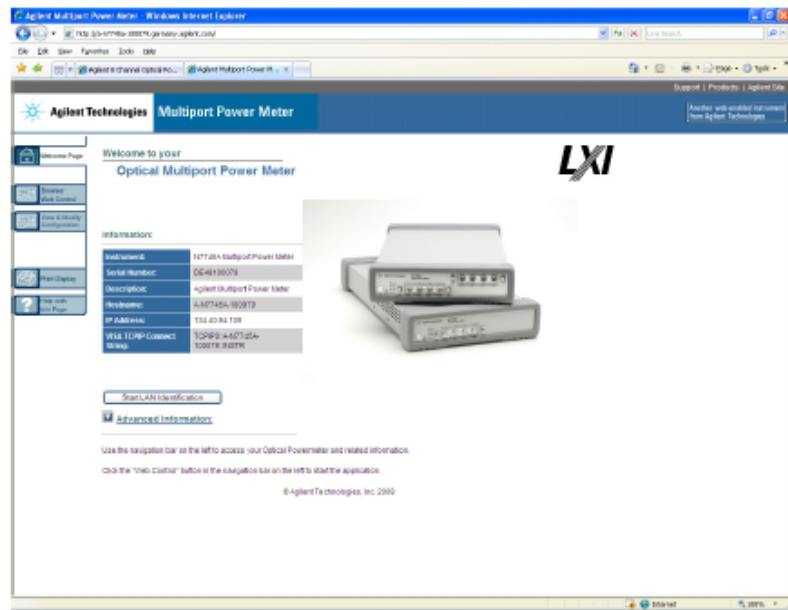


Figure 37

- 8 Select the instrument in the list to see the associated tasks (in the Task Guide on the left) and information (on the right).
  - For the N774x Multiport power meters, click on the “Instrument Web Interface” button to control the instrument directly.

## 1 Getting Started



**Figure 38**

If it is not already installed, you will need to install a Java run-time engine to use this page.

Basic configuration and functionality are available from this web page.

- You can control any of the instruments from the Keysight N77xx Viewer.
  - Connecting and using the N77xx Viewer is described in **“Connecting to the Instrument - Overview”** on page 40.

More advanced functionality is available through programming with SCPI commands (described in the Programming Guide available on the CD supplied with the instrument or from [www.Keysight.com](http://www.Keysight.com)), or using the 816x VXI Plug&Play driver, version 4.4 or higher. You can also use the IVI-COM driver for the N7744A and N7745A Multiport power meters.

## N77xx Viewer Common User Interface Functions

### Software Installation

The N77xx Viewer is a small user interface program that can be installed on a computer with Windows operating system. The installation package is distributed on the instrument CD and is available on the internet via the Package Manager at [www.Keysight.com/find/n7700](http://www.Keysight.com/find/n7700).

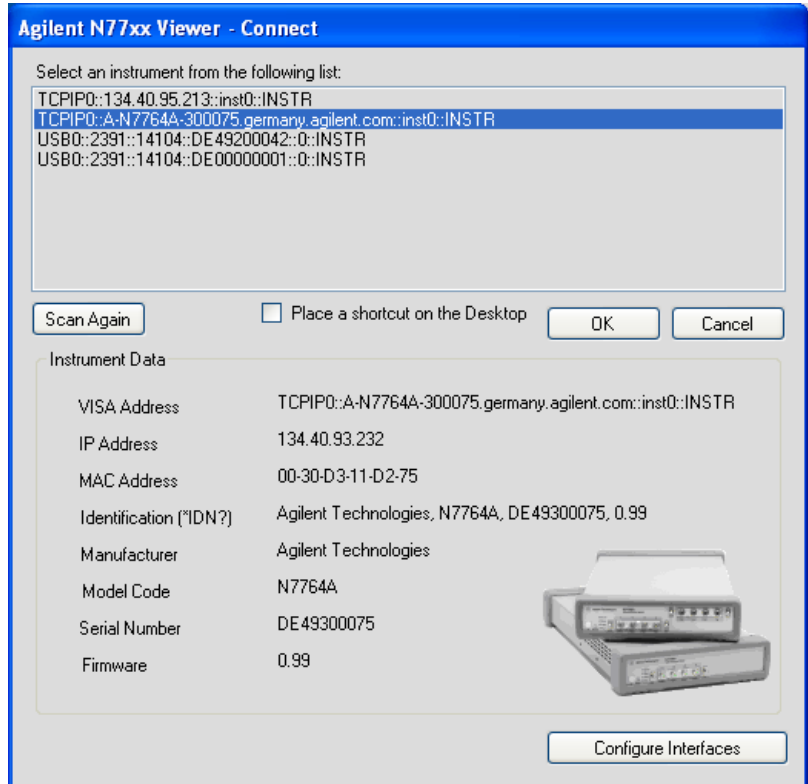
Using the Viewer also requires a VISA package to be installed, usually with the Keysight IO Library Suite.

### Connecting to an Instrument

When you first launch the N77xx Viewer, it is not connected to any of your instruments.

- 1 Click on the “Connect” icon at the top right of the window.
- 2 Select the instrument to which you want to connect from the list.





**Figure 39** Connecting to an Instrument

- 3 The list shows instruments that have been given a VISA address.

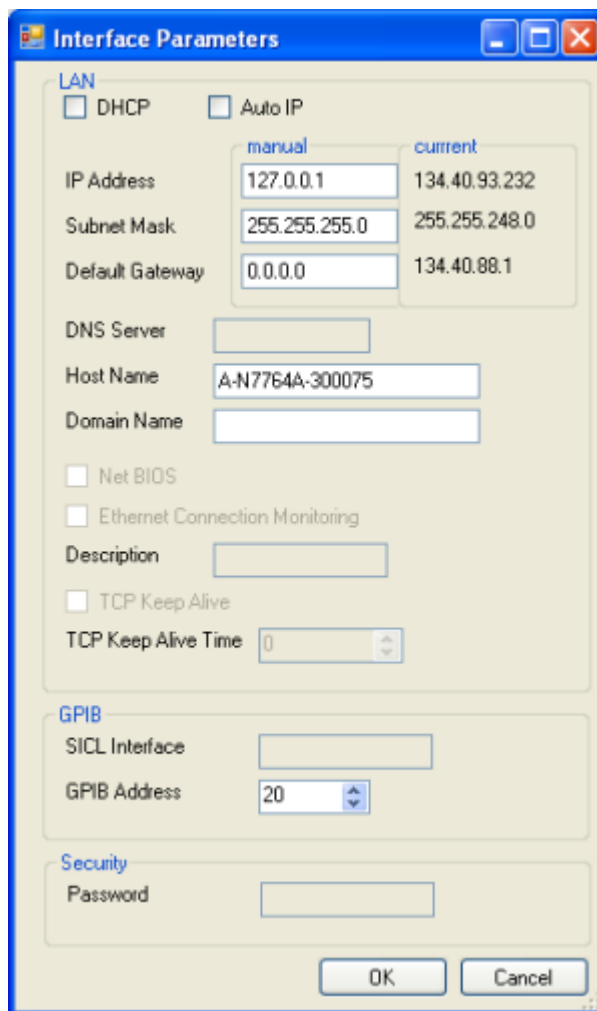
If your instrument is not in the list,

- 1 Use the Keysight Connection Expert to check your instrument has a VISA address
- 2 Click on the “Scan Again” button.

Once communication has been established to the instrument, its details are shown.

- 4 If you need to change the connection configuration for an instrument on the LAN, click on the “Configure Interfaces” button.

You can only configure the LAN parameters before the instrument is connected.



**Figure 40** Interface Parameters

- Make sure both DHCP and Auto IP are not selected.
  - You can now edit the IP parameters.
- 5 For instruments you use regularly, you can add a link on your desktop by putting a check mark in the box to “Place a shortcut on the Desktop”.
  - 6 Click on the “OK” button to finish the connection.

## Viewing Measurements and Settings

The settings and readings of the instrument can be accessed directly from the main Viewer panel. Instruments with multiple channels have a tab for each channel. In addition, separate windows can be opened for simply viewing the settings and readings, as follows:

### Viewing the measurement on a single channel

- 1 Click on the “New” button to open a window with the current measurement and parameter settings.



**Figure 41** Viewing the measurement on a single channel attenuator/power meter (left) or tunable laser (right)

### Viewing all channels

- 1 Click on "Overview" to open a window with the measurements on all channels.

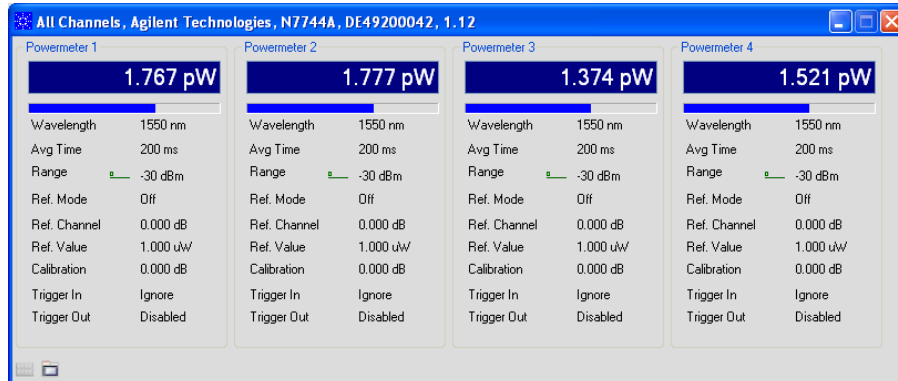


Figure 42 Viewing all channels

## Saving and Recalling Configurations

### Saving a configuration

You can save the current measurement configuration to either of two settings stored on the instrument.

- 1 In the File menu, select Save.
- 2 Enter or select the setting to which you want to save it.

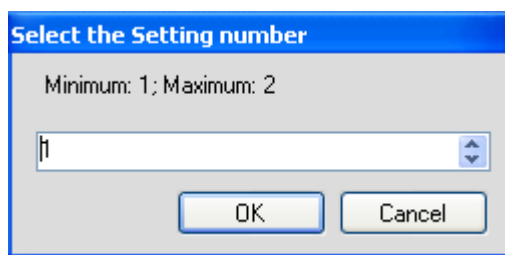


Figure 43 Saving a configuration

- 3 Click on the “OK” button.

### Recalling a configuration

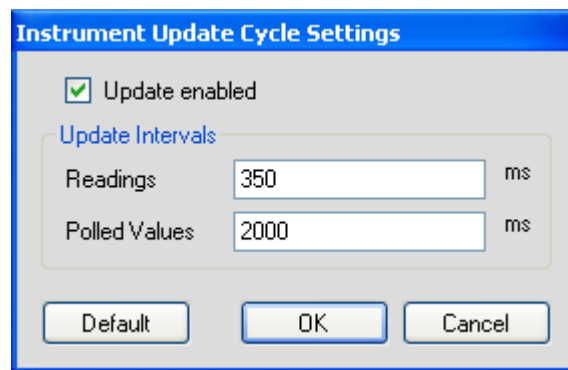
- 1 In the File menu, select Load.
- 2 Enter or select the setting you want to retrieve.

- 3 Click on the “OK” button.

## Controlling the Instrument Refresh

- 1 In the File menu, select Update.

In the dialog, you can :



**Figure 44** Controlling the Instrument Refresh

- Stop and start the display of all changes. Make sure to put a check in the box for “Update enabled”, to enable the N77xx Viewer to display the status and results from the instrument. If there is no check in the box for “Update enabled”, the display is not updated with the replies to queries sent to the instrument.
  - Set the update interval for “Readings” to control how often the result is read from the instrument and the display updated.
  - Set the update interval for “Polled Values” to control how often the measurement parameters are read from the instrument and the display updated. This is useful if, for example, more than one person can control the instrument.
- 2 When you have set all the values, click on the “OK” button.

# Index

## A

Adapters, 37  
Keysight N77-Series optical switch, 10  
Keysight N7745A, 7  
Keysight N7751A, 8  
Keysight N7752A, 8  
Keysight N7766A, 8  
Keysight N7768A, 8  
Angled contact connector, 28

## B

BNC connectors, 32

## C

Cables, 37  
Compact multichannel attenuators, 8  
Compact Tunable Laser, 9  
Connect angled contact fiber end connectors, 29  
Connector, 38  
Controlling the Instrument Refresh, 52

## E

Electrical Connectors, 32

## F

Front Panel Indicators, 40  
Front Panels - Multiport Power Meters, 24

Front Panels - Optical Attenuators, 25  
Front Panels - Optical Switches, 27  
Front Panels - Tunable Laser Source, 26

## G

GPIB interface, 37  
 GPIB Logic Levels, 38

## I

Input/Output Signals, 17  
Instrument Markings, 18  
IP address, 33

## L

Laser class 1M label, 16  
laser safety labels, 16  
Line Power Cable, 19  
Line Power Connectors, 17  
Line Power Requirements, 15

## M

Multimode attenuators, 28

## N

N7747A, 8  
N7748A, 8

## O

Operating Environment, 15  
Optical connectors, 28  
Optical attenuators, 28

## P

Power Meters, 8

## R

Rear Panel, 27  
Recalling a configuration, 51

## S

Safety, 13  
Safety Considerations, 13  
Safety Information for Tunable Laser Modules, 15  
Safety Symbols, 13  
Saving a configuration, 51  
Software Installation, 47  
Straight contact connectors, 29

## T

Temperature for operation and storage, 21

## U

USB Interface, 39

## **Index**

### **V**

Viewing Measurements and Settings,  
50







This information is subject to change without notice.  
© Keysight Technologies 2015  
Edition 7.0, March 2015



N7744-90A01

[www.keysight.com](http://www.keysight.com)