



DATASHEET RFSU Specification V1.36

Ultra-Low Noise Microwave Signal Generators

8 kHz to 12.75, 20, 26 and 40 GHz



Document size:

1 title page
18 content pages

DEFINITIONS

- The specifications in the following pages describe the warranted performance of the instrument for 23 ± 5 °C after a 30-minute warm-up period.

Typical: Expected mean values, not warranted performance

Min and max: Parameter range that is guaranteed by product design, and/or production tested. Warranted performance specifications include guard-bands to account for the expected statistical performance distribution, measurement uncertainties, and changes in performance due to environmental conditions.

INTRODUCTION

• Ultra-Low Noise Microwave Signal Generator 8 kHz to 12.75, 20, 26 and 40 GHz

The RFSU is an ultra-low-noise and fast-switching microwave signal generator covering a continuous frequency range from 100 kHz (8 kHz with option) up to 12.75, 20 GHz, 26 or 40 GHz, respectively, with a lower than 0.001 Hz resolution.

The RFSU provide an accurately levelled output power range and high spurious suppression. Advanced frequency synthesis combines fastest switching speed with ultra-low SSB phase noise and fine frequency and power resolution.

The RFSU supports analog modulation including pulse and chirp modulation with programmable patterns.

The RFSU allows for fast digital sweeps including flexible list sweeps, where frequency, power and dwell times can be set individually. A flexible triggering system simplifies synchronization within test environments.

All RFSU operate with ultra-stable temperature compensated frequency reference (OCXO) to ensure minimal drift and can be phase-locked to an external reference.

The compact unit allows for full front panel control via touch panel display. It can also be intuitively controlled by a PC based GUI Software. Moreover, the instrument offers various communication interfaces like USB, LAN or GPIB. Each interface allows for easy and fast communication using SCPI 1999 command set. Remote control of the instrument can be quickly attained from any host system. A customer-supplied application programming interface (API) or programming examples for Matlab, Labview, C++ and other commercially available tools make the control implementation very straightforward.

FACTS & FIGURES & SPECIFICATIONS

Signal Specifications

PARAMETER	MIN	TYPICAL	MAX	NOTE
Frequency Range	100 kHz		12.75 GHz	RFSU12
	100 kHz		20 GHz	RFSU20
	100 kHz		26 GHz	RFSU26
	100 kHz		40 GHz	RFSU40
	8 kHz		Fmax	Option 8K
Resolution		0.001 Hz		
Phase Resolution		0.01 deg		
Switching Speed		1.5 ms		Valid signal after SCPI received.
SCPI CW mode		500 μs		
Sweep / List Mode		30 μs		
SSB Phase noise at 1 GHz				(see also plots / tables)
at 10 Hz from carrier		-87 dBc/Hz		Option LN
at 1 kHz from carrier		-100 dBc/Hz	-95 dBc/Hz	
at 100 kHz from carrier		-130 dBc/Hz	-125 dBc/Hz	
SSB Phase noise at 4 GHz				
at 10 Hz from carrier		-74 dBc/Hz	-70 dBc/Hz	Option LN
at 1 kHz from carrier		-90 dBc/Hz	-85 dBc/Hz	
at 100 kHz from carrier		-118 dBc/Hz	-114 dBc/Hz	
SSB Phase noise at 10 GHz				
at 10 Hz from carrier		-67 dBc/Hz	-62 dBc/Hz	Option LN
at 1 kHz from carrier		-80 dBc/Hz	-75 dBc/Hz	
at 100 kHz from carrier		-108 dBc/Hz	-104 dBc/Hz	
SSB Phase noise at 40 GHz				
at 10 Hz from carrier		-55 dBc/Hz	-50 dBc/Hz	Option LN
at 1 kHz from carrier		-68 dBc/Hz	-64 dBc/Hz	
at 100 kHz from carrier		-96 dBc/Hz	-92 dBc/Hz	
Harmonics (at +0 dBm Pout)				
0.01 to 6 GHz		-40 dBc	-30 dBc	See plot
>6GHz		-35 dBc	-25 dBc	
Option FILT, >1 GHz		-60 dBc	-50 dBc	
Sub-Harmonics (at +0 dBm)				
<5 GHz		-75 dBc	-65 dBc	
5 - 20 GHz		-70 dBc	-60 dBc	
>20 GHz		-55 dBc	-50 dBc	
Option FILT, >20 GHz		-65 dBc	-55 dBc	
Non-Harmonic Spurious (at +0 dBm)				> 10 kHz offset
<1.2 GHz		-90 dBc	-60 dBc	
1.2 - 2.5 GHz		-92 dBc	-55 dBc	
2.5 - 5 GHz		-90 dBc	-55 dBc	
5 - 10 GHz		-84 dBc	-55 dBc	
10 - 20 GHz		-80 dBc	-55 dBc	
>20 GHz		-70 dBc	-50 dBc	

PARAMETER	MIN	TYPICAL	MAX	NOTE
Output power range				
0.1 to 10 MHz	-25 dBm		+24 dBm	
0.01 to 6 GHz	-25 dBm		+25 dBm	
6 to 12.75 GHz	-25 dBm		+24 dBm	
12.75 to 26 GHz	-25 dBm		+21 dBm	
26 to 40 GHz	-25 dBm		+18 dBm	See plots
Output power range (with electrical step attenuator, option PE4)				
0.1 to 10 MHz	-55 dBm		+23 dBm	
0.01 to 6 GHz	-55 dBm		+24 dBm	
6 to 12.75 GHz	-55 dBm		+22 dBm	
12.75 to 20 GHz	-55 dBm		+20 dBm	
20 to 30 GHz	-55 dBm		+17 dBm	
30 to 40 GHz	-55 dBm		+14 dBm	See plot
Output power range (with mechanical step attenuator, option PE)				
0.1 to 10 MHz	-90 dBm		+26 dBm	
0.01 to 6 GHz	-90 dBm		+24 dBm	
6 to 12.75 GHz	-90 dBm		+22 dBm	
12.75 to 20 GHz	-90 dBm		+21 dBm	
20 to 30 GHz	-90 dBm		+18 dBm	
30 to 35 GHz	-90 dBm		+17 dBm	
35 to 40 GHz	-90 dBm		+16 dBm	
Output power range (with mechanical step attenuator, option PE2, must have option 1URM)				
0.1 to 10 MHz	-120 dBm		+23 dBm	
0.01 to 6 GHz	-120 dBm		+24 dBm	
6 to 12.75 GHz	-120 dBm		+22 dBm	
12.75 to 20 GHz	-120 dBm		+21 dBm	
20 to 30 GHz	-120 dBm		+17 dBm	
30 to 35 GHz	-120 dBm		+16 dBm	
35 to 40 GHz	-120 dBm		+15 dBm	See plot
Output power range (with option FILT)				
0.1 to 10 MHz	-30 dBm		+15 dBm	
0.01 to 20 GHz	-30 dBm		+13 dBm	
20 to 40 GHz	-30 dBm		+10 dBm	See plot
Power Resolution		0.01 dB		
Power Level Uncertainty				
<6 GHz		0.25 dB	0.8 dB 1.2 dB 2.0 dB	-15 to +15 dBm -60 to -15 dBm or >15 dBm -100 to -60 dBm
6 to 12.75 GHz		0.3 dB	0.9 dB 1.3 dB 2.0 dB	-15 to +15 dBm -60 to -15 dBm or >15 dBm -100 to -60 dBm
12.75 to 26 GHz		0.3 dB	1.0 dB 1.6 dB 2.5 dB	-15 to +15 dBm -60 to -15 dBm or >15 dBm -100 to -60 dBm
26 to 40 GHz		0.4 dB	1.2 dB 2.5 dB 3.5 dB	-15 to +15 dBm -55 to -15 dBm or >15 dBm -100 to -60 dBm
Reverse Power Protection				
DC Voltage			±10 V	
RF Power			30 dBm	
Output impedance				
VSWR		50 Ohms	1.4	1.9



Modulation Capabilities (Option MOD)

PARAMETER	MIN	TYPICAL	MAX	NOTE
Pulse Modulation				
Modulation source		Internal/ External		
Pulse rise/fall time		10 ns		
On/off ratio (high ON/OFF mode)		80 dB 75 dB	70 dB 65 dB	Pout > +10 dBm, f<18 GHz > 18 GHz
Pulse overshoot			10%	
Pulse delay		20 ns		
Pulse polarity		Normal, inverse		selectable
External input threshold	0.85 V	0.9 V	0.95 V	TTL compatible
External input voltage range	-0.5 V		+5.5 V	TTL compatible
External input hysteresis		60 mV		
Internal pulse generator				
Repetition frequency (PRF)	0.1 Hz		50 MHz	= 1/T
Duty cycle	1 % to 99 % in 1% steps			within specified minimum pulse width
Minimum pulse settling range	30 ns 10 ns		20 s 20 s	Option FS
Pulse Pattern Modulation & Staggered PRF				Using internal pattern generator
Programmable pattern length	2		65536	
Duty cycle	0.05%		99.95%	
Pulse width resolution		5 ns		
Pulse period (T) accuracy		0.00005xT+ 3ns		
Pulse width accuracy		0.00005xT+ 5ns		
Pulse width resolution		5 ns		
Pulse jitter		1 ns	5 ns	
Polarity		selectable		
Chirped Pulse Modulation				
Option FS & MOD				
Modulation source		Internal		
Chirp span	1 Hz		3 %	of RF
Chirp rate	1 Hz		100 kHz	
Pulse width	10 μs		1 sec	
Chirp slope			0.5% / μs	of RF
Chirp mode		Linear, exponential, up, down, bidirectional		
Frequency Modulation				
Modulation source		Internal/ (External)		
Maximum Frequency deviation (peak)		N · 200 MHz		< 1.25 GHz (N=1) 1.25 GHz to 2.5 GHz (N=0.125) 2.5 GHz to 5 GHz (N=0.25) 5 GHz to 10 GHz (N=0.5) 10 GHz to 20 GHz (N=1) 20 GHz to 40 GHz (N=2)
Deviation accuracy		0.50%	2%	
Distortion (THD)		< 1 %		1 kHz rate, 10 kHz deviation
Modulation rate	0.1 Hz		80 kHz	

Modulation waveforms	Sine			
External input voltage range	0 V		+10 V	Input voltage must be positive
External input termination		600 Ohms		Internal termination
External input coupling		AC		Cutoff 1 Hz typical (-3 dB) DC coupling on request
Phase Modulation				
Modulation source		Internal/ (External)		
Phase deviation (peak)	0		$300 \cdot N \cdot \text{rad}$	
Deviation accuracy		0.50%	2%	
Modulation rate	0.1 Hz		80 kHz	
Modulation waveforms	Sine			
Distortion (THD)	< 1%			1 kHz rate & N x rad deviation
External input voltage range	0 V		+10 V	Input voltage must be positive
External input termination		600 Ohms		Internal termination
External input coupling		AC		Cutoff 1 Hz typical (-3 dB)

Sweeping Capability, Sweep type: linear, logarithmic, random

PARAMETER	MIN	TYPICAL	MAX	NOTE
Sweep Parameters	Frequency, power, phase, list			
Step time (t_{step})	500 μs 30 μs		19998 s 19998 s	Option FS
Settling time (t_{inv})			15 μs	To stabilize phase and amplitude, depends on frequency step
Trigger latency (t_{de})			1 μs	Time from trigger to initiate signal transient
Time resolution		5 ns		
Timing accuracy per point		5 ns		

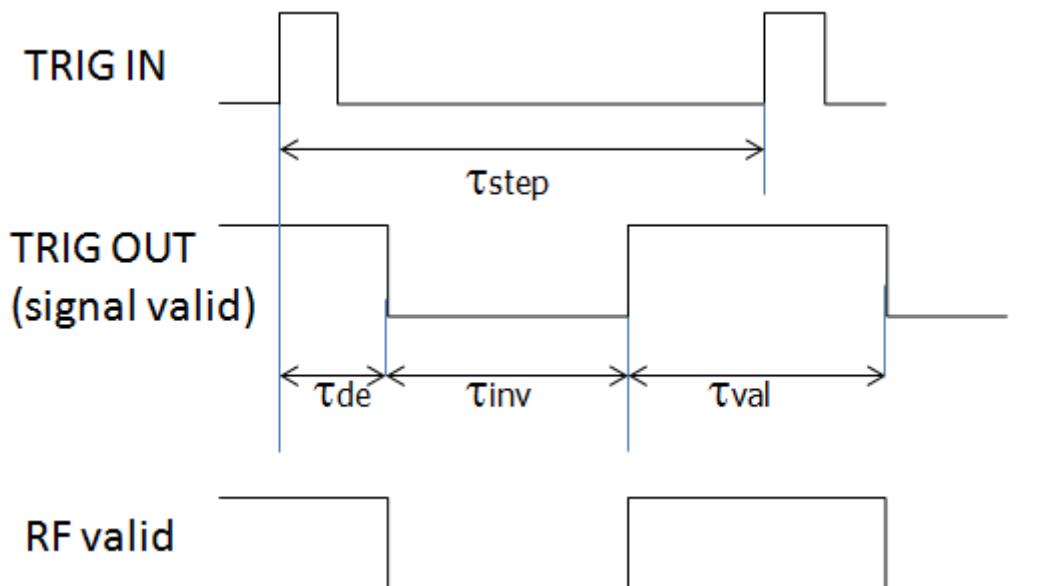

Frequency Reference

PARAMETER	MIN	TYPICAL	MAX	NOTE
Internal Reference Frequency		100 MHz 10 MHz		Option LN
Temperature Stability 0 to 50 °C			±100 ppb ±20 ppb	Option LN
Aging first year			1 ppm 0.03 ppm	Option LN
Aging per day			5 ppb 0.5 ppb	after 30 days operations Option LN
Warm-up time		5 min		
Output of internal reference		100 MHz 10/100 MHz		Option LN
Output power		0 dBm		
Output impedance		50 Ohms		
Bypass Internal reference Input		100 MHz		High phase synchronous mode
Phase Lock to External Reference		10 MHz integer MHz 100 MHz	250	Option VREF
Bypass Mode	5			
Reference input level				
10 MHz or 1-250 MHz	-5 dBm	0 dBm	+10 dBm	
100 MHz	5 dBm		+15 dBm	
Lock Range				
10 MHz or 1-250 MHz			±1.5 ppm	
100 MHz			>100 ppm	
Reference input impedance		50 Ohms		

Trigger (TRIG IN): Input is TRIG IN at front panel

PARAMETER	MIN	TYPICAL	MAX	NOTE
Trigger Types	Continuous, single (point), gated, gated direction			
Trigger Source	external, bus (LAN, USB)			
Trigger Modes	Continuous free run, trigger and run, reset and run			
Trigger latency		5 ns		
Trigger uncertainty		10 ns		
External Trigger delay	50 ns		40 s	settable
External Delay Resolution		5 ns		
Trigger Modulo	1		255	Execute only on Nth trigger event
Trigger Polarity	Rising, falling			
External trigger input threshold	0.85 V	0.9 V	0.95 V	TTL compatible
External trigger input voltage range	-0.5 V		+5.5 V	TTL compatible
External trigger input hysteresis		60 mV		

TYPICAL PERFORMANCE CURVES

SSB Phase Noise Performance with option LN

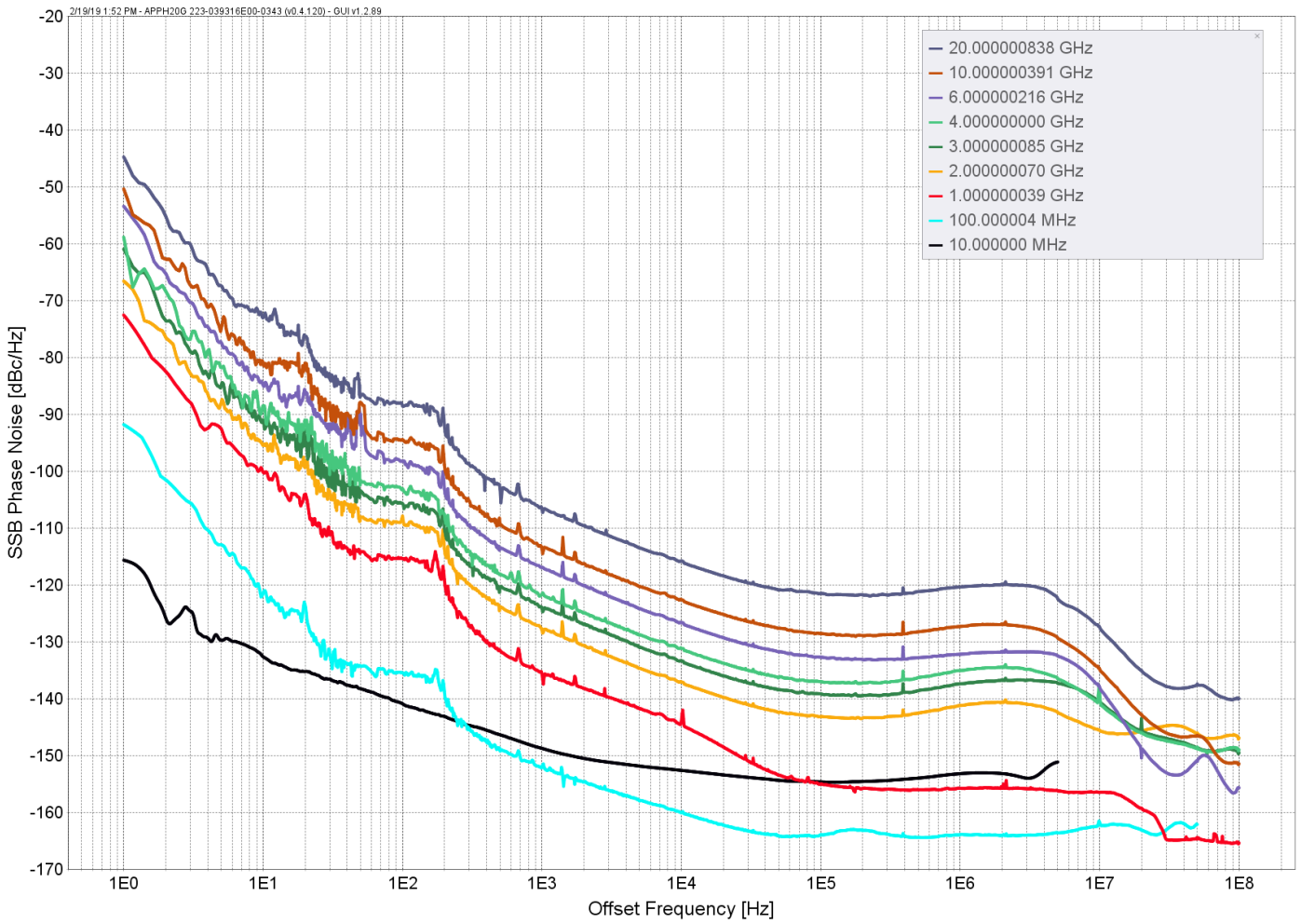

Typical SSB Phase Noise [dBc/Hz], CW, level = 20 dBm, Option LN

Offset → RF ↓	1 Hz	10 Hz	100 Hz	1 kHz	10 kHz	100 kHz	1 MHz	floor
10 MHz	-116	-133	-141	-149	-153	-155	-154	-155
100 MHz	-96	-121	-137	-148	-157	-162	-162	-162
1 GHz	-76	-100	-120	-132	-142	-153	-156	-165
2 GHz	-70	-94	-114	-125	-135	-143	-143	-155
3 GHz	-66	-90	-110	-122	-132	-139	-139	-151
4 GHz	-64	-88	-108	-118	-129	-137	-137	-151
6 GHz	-60	-84	-104	-115	-124	-132	-133	-151
10 GHz	-56	-80	-100	-111	-121	-129	-129	-151
20 GHz	-50	-74	-94	-105	-116	-123	-123	-150

SSB Phase Noise Performance, without option LN

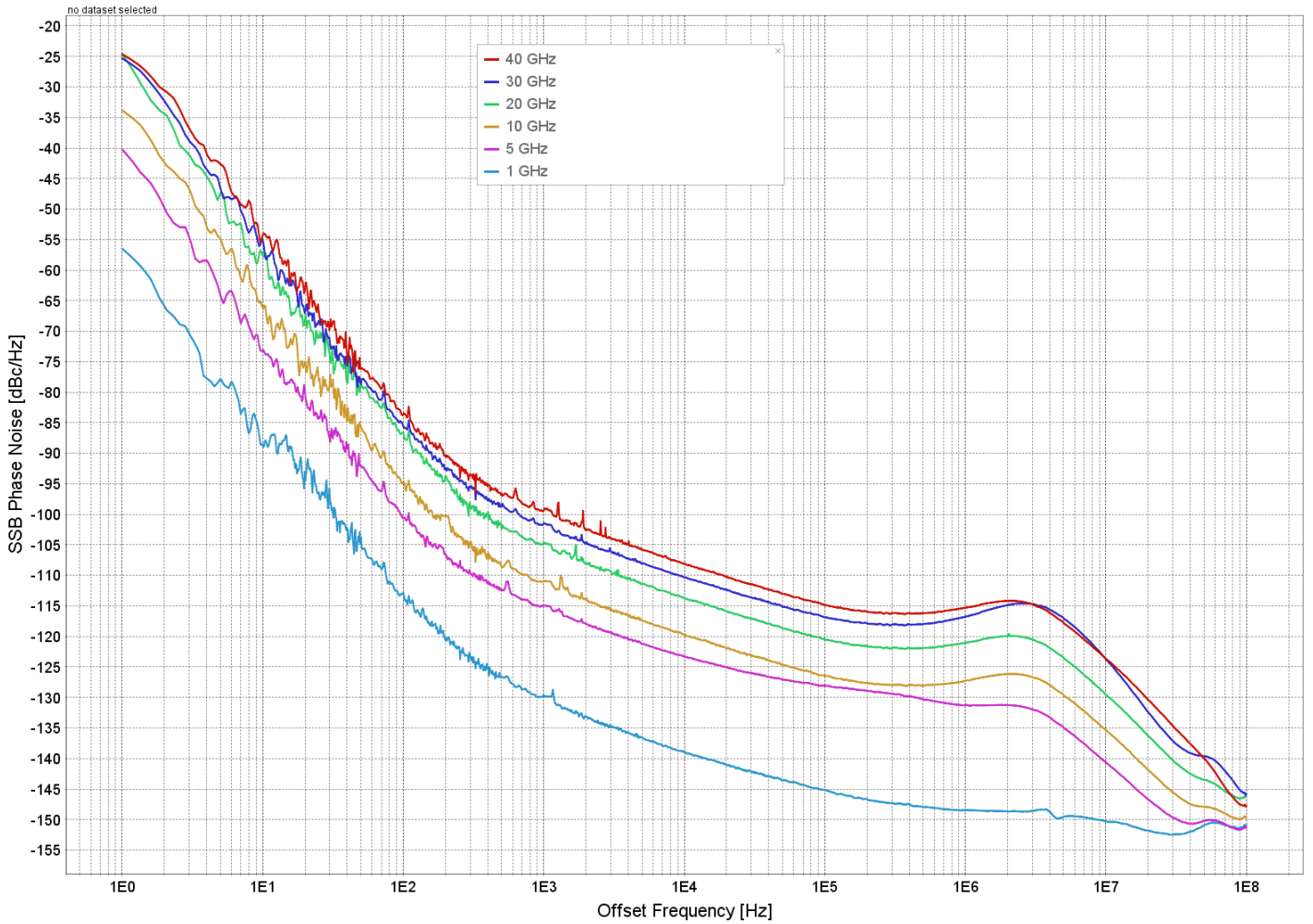

Typical SSB Phase Noise [dBc/Hz], CW, level = 20 dBm, without option LN

Offset → RF ↓	1 Hz	10 Hz	100 Hz	1 kHz	10 kHz	100 kHz	1 MHz	floor
10 MHz	-96	-128	-146	-149	-153	-155	-154	-155
100 MHz	-76	-108	-140	-148	-157	-162	-162	-162
1 GHz	-57	-88	-114	-130	-140	-145	-150	-165
5 GHz	-41	-74	-101	-116	-123	-128	-131	-151
10 GHz	-37	-68	-95	-111	-121	-127	-127	-151
20 GHz	-31	-62	-90	-105	-116	-121	-121	-150
40 GHz	-25	-56	-84	-100	-110	-115	-115	-150

Maximum Output Power 0.01 to 40 GHz

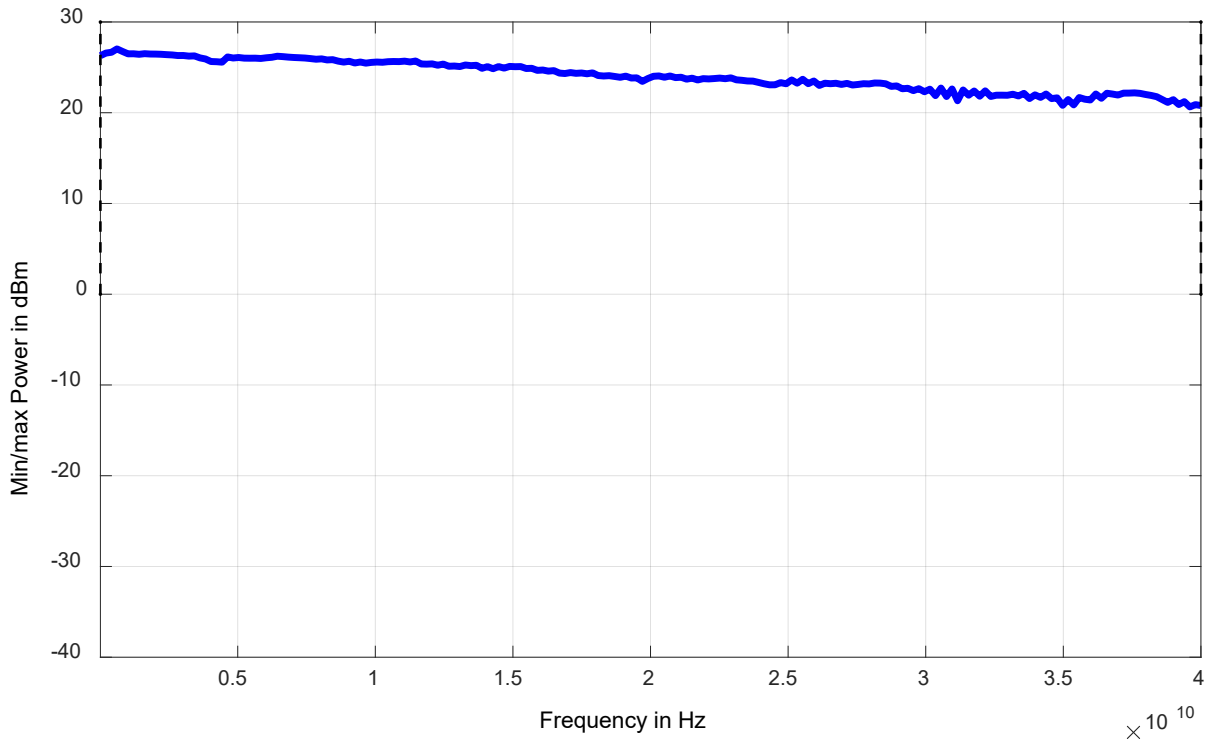

Max Output Power 0.01 to 40 GHz (RFSU40 with option PE4)

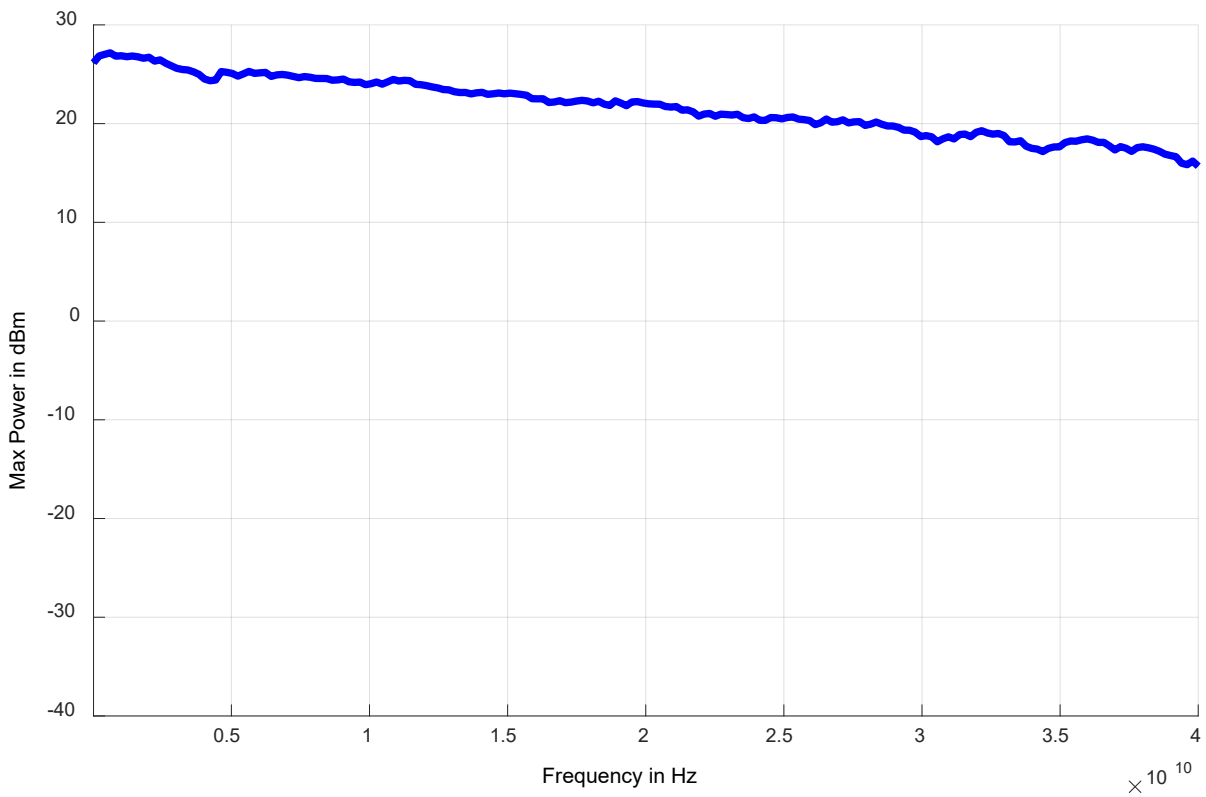

Max Output Power 0.01 to 40 GHz (with option FILT)

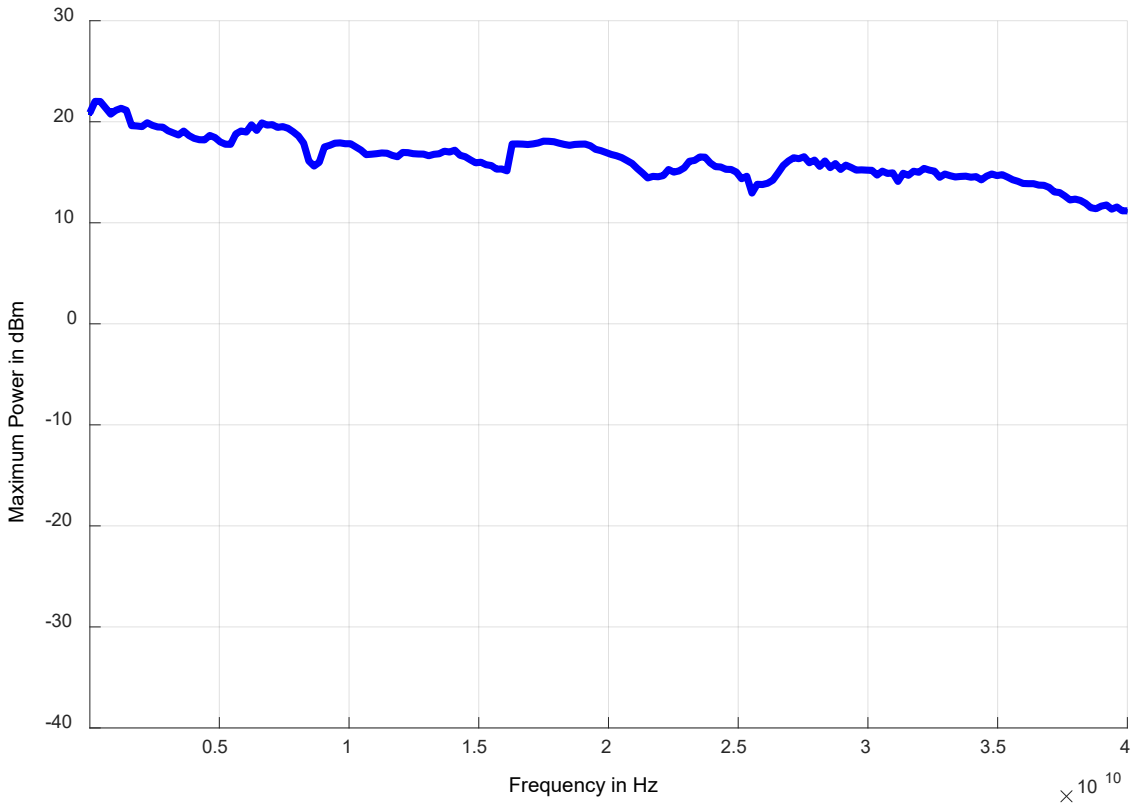

Max Output Power 0.01 to 40 GHz (with option PE2)



Max Output Power 0.01 to 40 GHz (with option 8K)

tba

Harmonics (2nd, 3rd at P=+5 dBm, RFSU40 with option FILT)

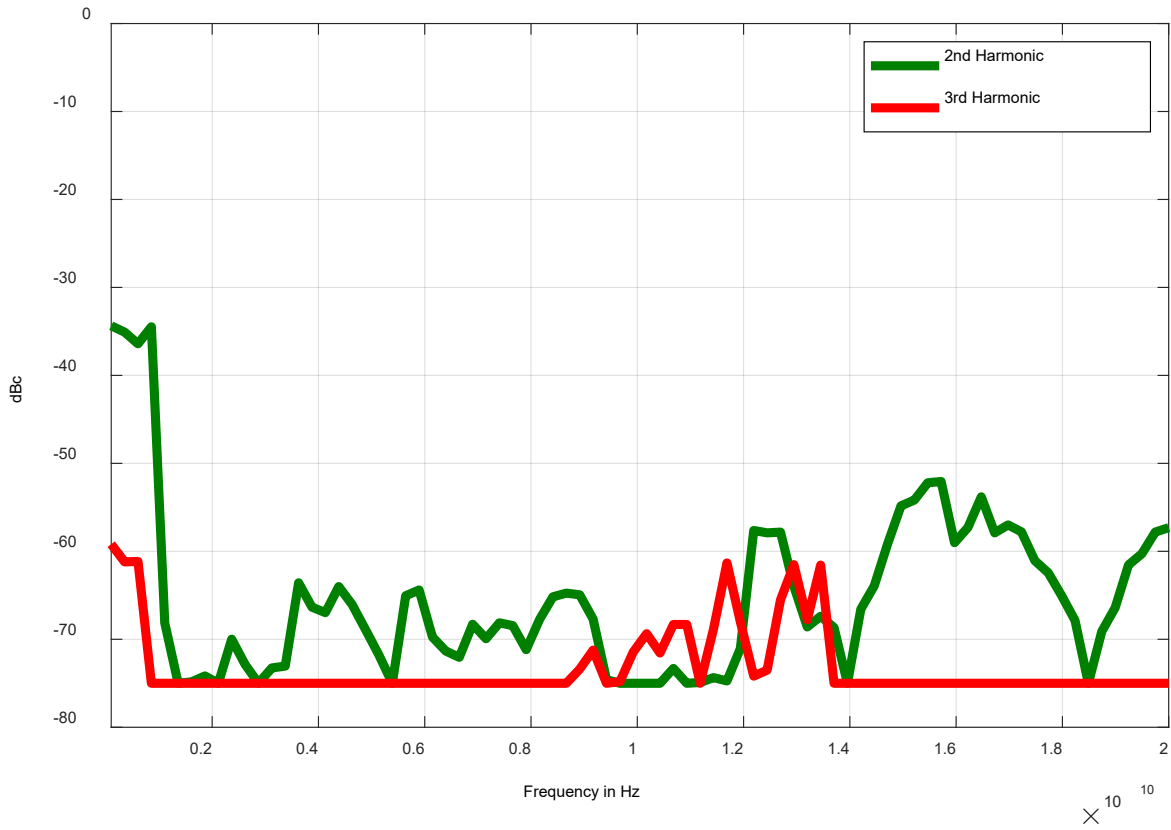

Harmonics (2nd, 3rd at P=+10 dBm, RFSU20)

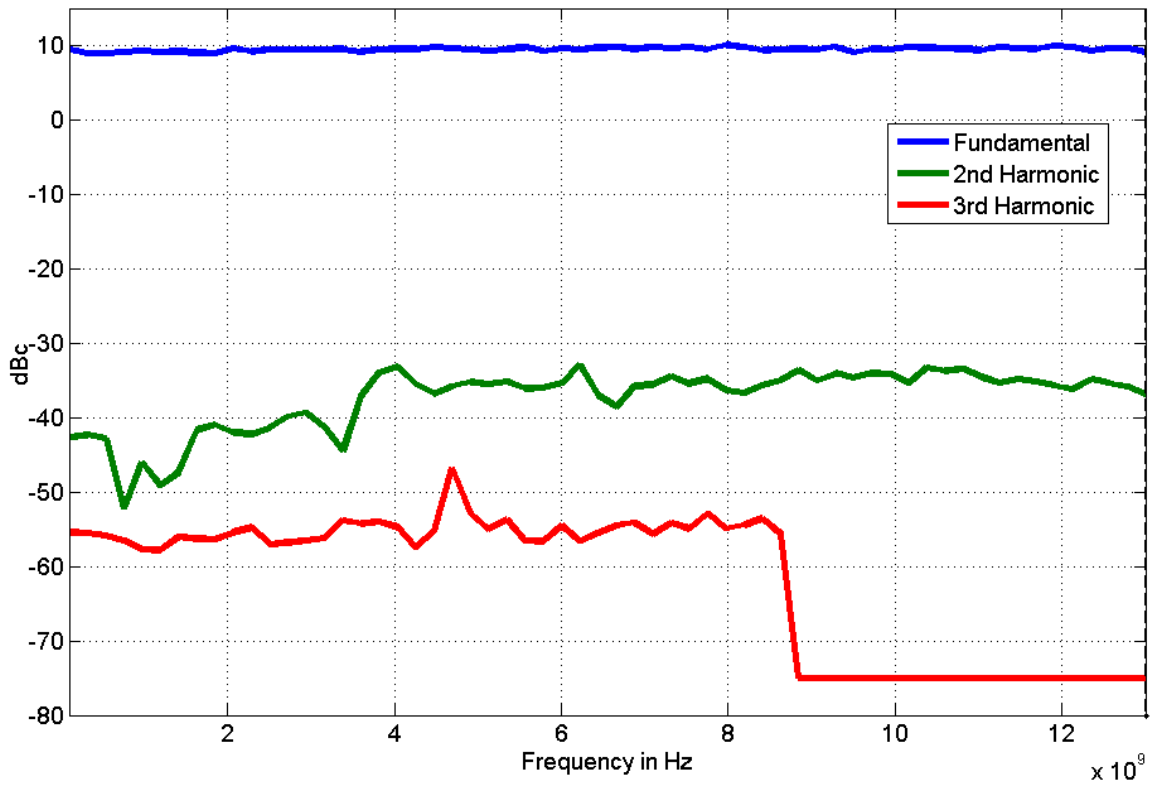

Typical Frequency Response 0 to 20 GHz at different power levels (RFSU20)

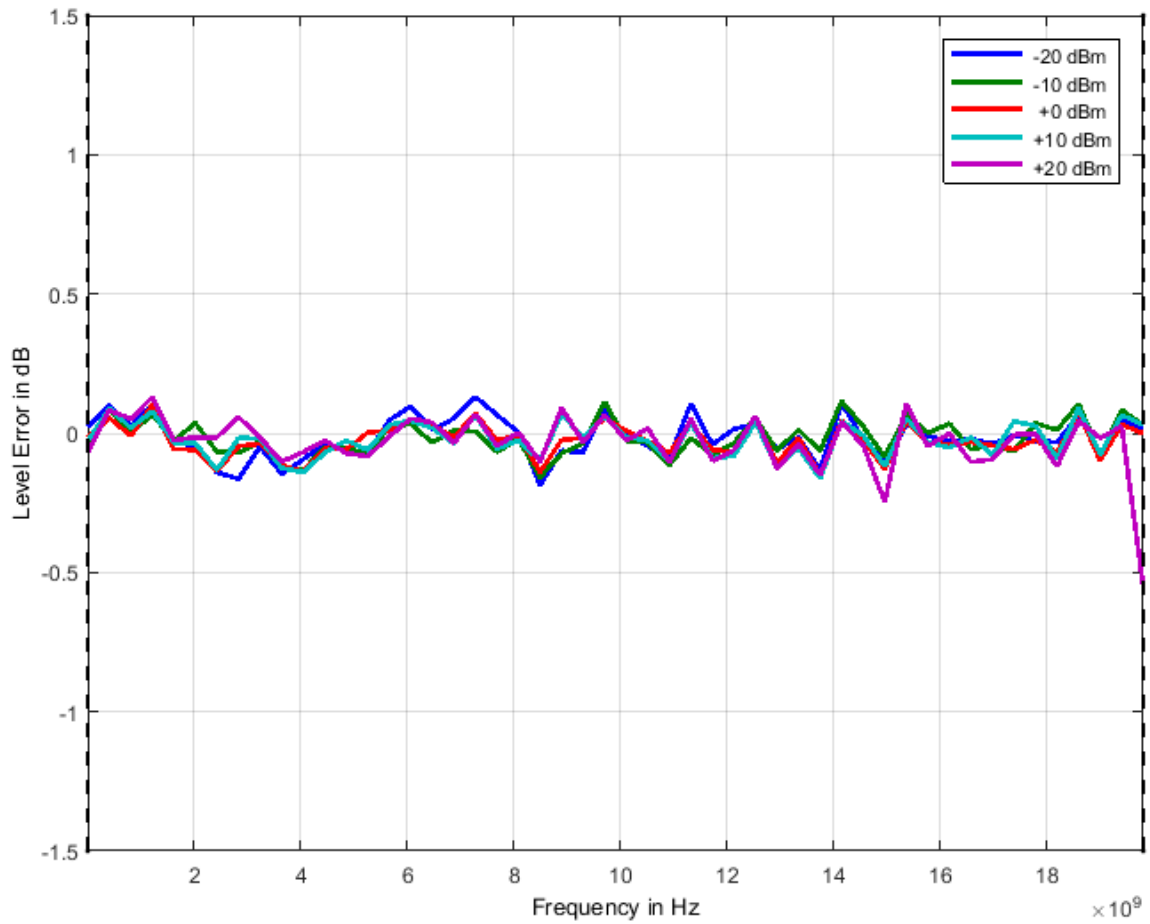

Typical Output Power Linearity (RFSU40)

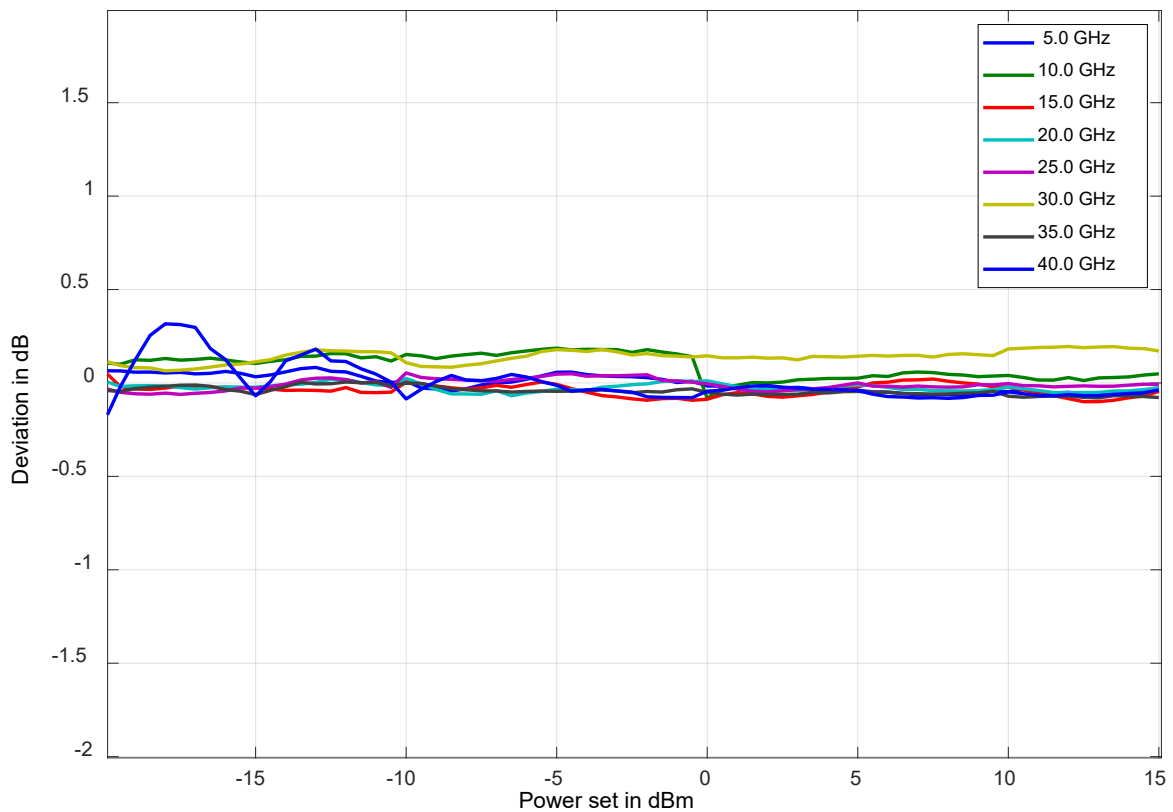

Typical VSWR (RFSU20)

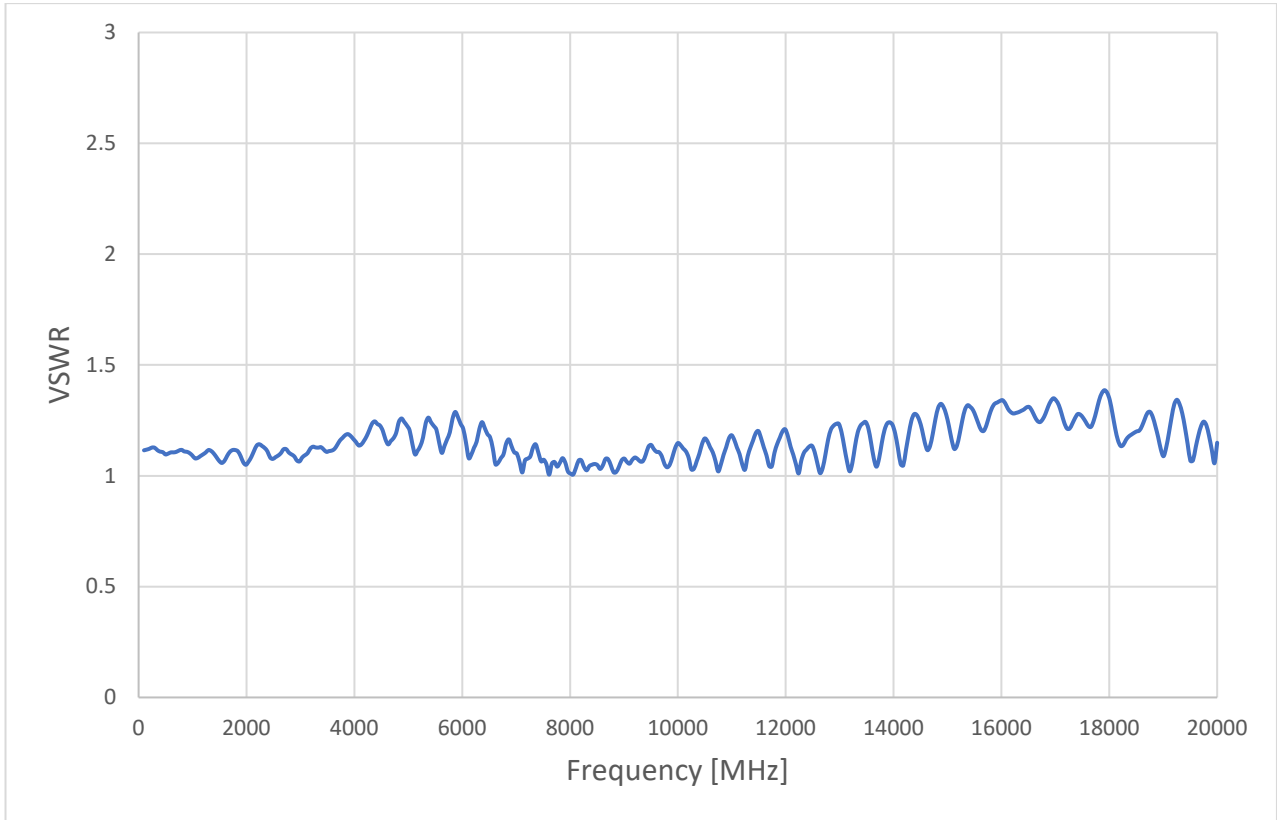

Internal Pulse Modulation (10 GHz, 40ns period, 15 ns pulse width)

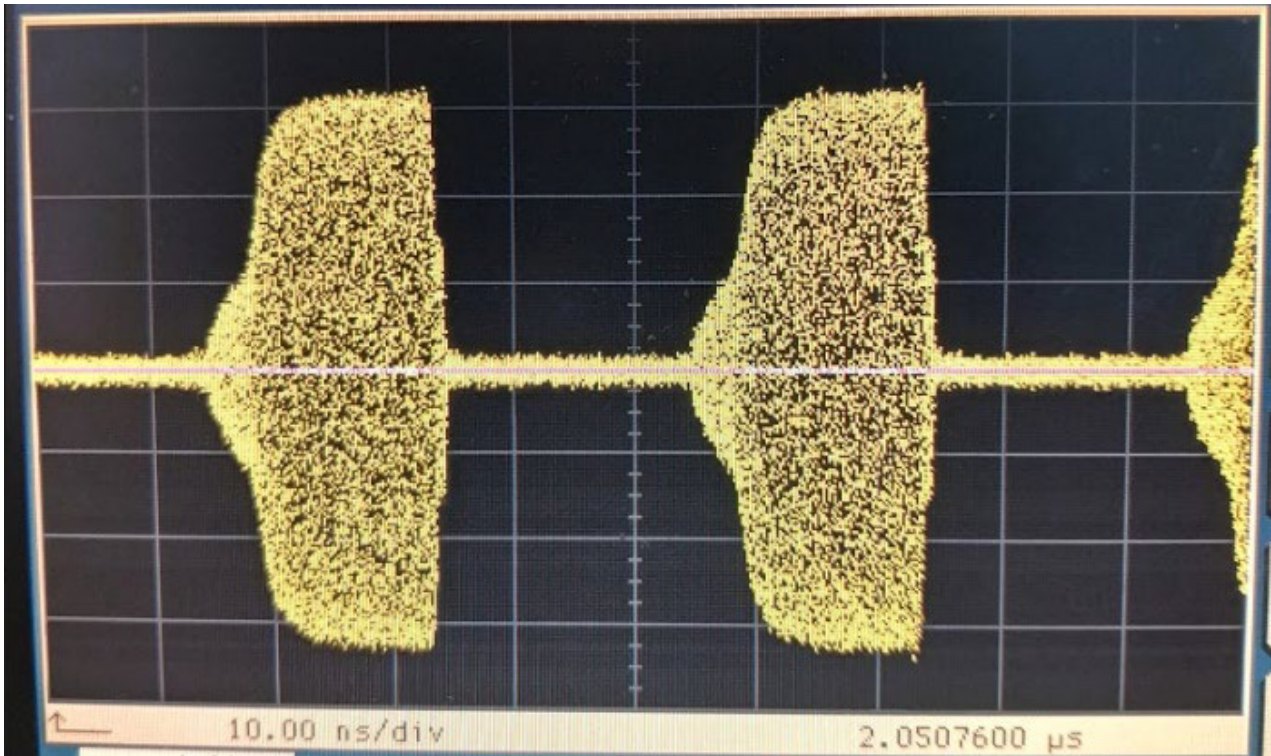

Internal Pulse Modulation (38.8 GHz, 15ns period, 7 ns pulse width)

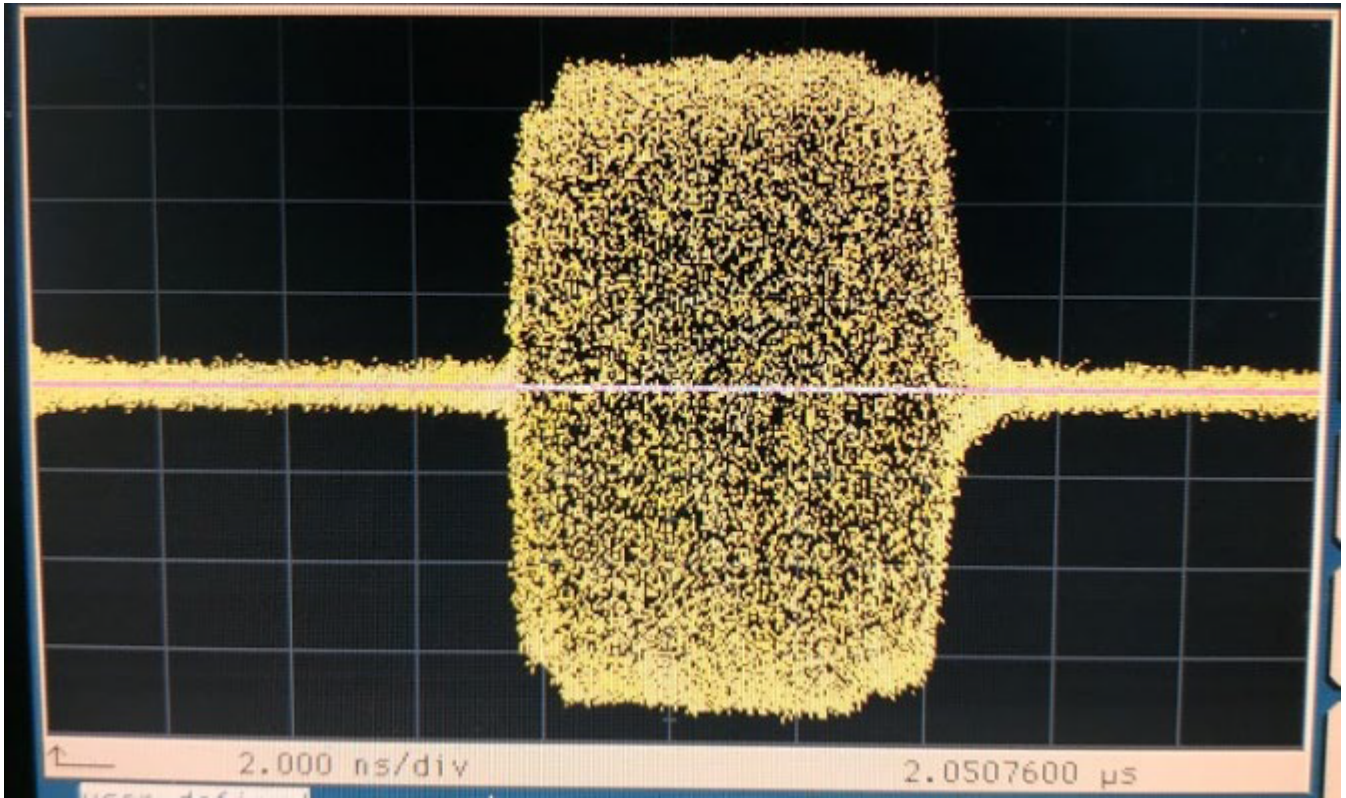

Front panel:

1. RF output:

RFSU40: K (2.92 mm) female

RFSU06,12,2026: SMA female

2. Rotary knob



Rear panel:

1. TRIG IN: Trigger input: BNC female

2. TRIG OUT: Trigger output: BNC female

3. REF OUT: Internal reference output: BNC female

4. REF IN: External reference input: BNC female

5. MOD IN modulation input for AM/FM/PM: BNC female

6. PULSE IN: Pulse modulation input: BNC female

7. LAN connection: RJ-45

8. USB 2.0 host and device

9. GPIB: IEEE-488.2, 1987 with listen and talk (optional)

10. DC Power plug (24V, 3 A)

11. DC power switch

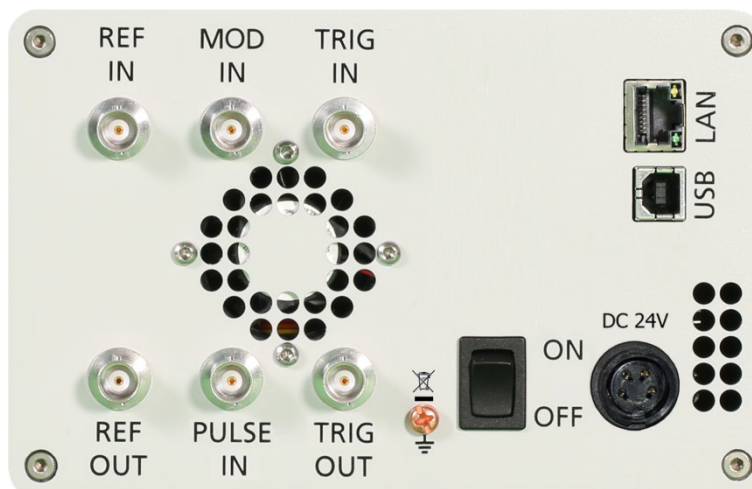

ORDERING INFORMATION



HOST MODEL	PRODUCT	DESCRIPTION
RFSU12	RFSU12	100 kHz – 12.75 GHz
RFSU20	RFSU20	100 kHz – 20 GHz
RFSU26	RFSU26	100 kHz – 26 GHz
RFSU40	RFSU40	100 kHz – 40 GHz
RFSUXX	Option LN	Enhanced close in phase noise & frequency stability
RFSUXX	Option FS	Ultra-fast switching speed
RFSUXX	Option MOD	Analog modulation
RFSUXX	Option FILT	Enhanced harmonic rejection
RFSUXX	Option 8K	Frequency range extension to 8 kHz
RFSUXX	Option VREF	Variable external Reference
RFSU12	Option PE4-12	Electrical step attenuator (12 GHz version)
RFSU20/26	Option PE4-20/26	Electrical step attenuator (20 & 26 GHz version)
RFSU40	Option PE4-40	Electrical step attenuator (40 GHz version)
RFSU12/20/26/40	Option PE	Mechanical step attenuator down to -90 dBm (12, 20, 26 & 40 GHz version)
RFSU12/20/26/40	Option PE2	Mechanical step attenuator down to -120 dBm (12, 20, 26 & 40 GHz version)
RFSUXX	Option EB	Adapter cable to external power bank
RFSUXX	Option GPIB	GPIB interface
RFSUXX	Option LH	Desktop housing with color touch display
RFSUXX	Option 1URM	19" 1HU rack enclosure
RFSUXX	Option REAR	Move output to the rear
RFSUXX	Option FLASH	MicroSD card slot for removable microSD memory
RFSUXX	Option WE	One year warranty extension
RFSUXX	Option ReCal	Recalibration with test data
RFSUXX	Option Retrofit	Applies when options are back-ordered

GENERAL CHARACTERISTICS

Remote programming interfaces

Ethernet 100BaseT LAN interface,
USB 2.0 host & device
GPIB (IEEE-488.2,1987) with listen and talk (optional)
Control language SCPI Version 1999.0

Power requirements 24V ± 3.0 VDC; 25 W maximum

Mains adapter supplied: 100-240 VAC in/ 24 V 4.0 A DC out

Environmental (Levels similar to MIL-PRF-28800F Class 3/4)

Environmental stress Samples of this product have been type tested to be robust against the environmental stresses of storage, transportation, and end-use; those stresses to temperature, humidity, shock, vibration, altitude, and power line conditions.

Operating temperature range 0 to 45 °C

Storage temperature range -40 to 70 °C

Operating and storage altitude up to 15,000 feet (4600 m)



notice

EMC complies and EMC regulations and directives for emission and immunity to interference (EN 61326-1 Industrial, EN/IEC 61326-2-1).

Safety complies with applicable Safety regulation in line with IEC/EN 61010-1

This product complies with directive 2011/65/EU

Weight 2.5 kg (6 lbs) net, ≤ 4 kg (8 lb.) shipping

Dimensions 106 mm H x 172 mm W x 290 mm L (incl. connectors) [4.21 in H x 6.77 in W x 11.42 in L]

Recommended calibration cycle 24 months



Document History

Version/Status	Date	Author	Notes
V123	2019-02-28	jk	New layout
V124	2019-03-21	jk	Min. Pulse width w. option FS
V125	2019-10-1	jk	Pulsed chirps w. option FS
V126	2019-10-21	jk	Max power settings revised
V130	2020-01-26	jk	Option FILT added
V131	2020-05-21	jk	Option 8K added
V132	2020-07-21	jk	Refined power ranges, plots added
V133	2021-02-25	db	Pulse and trigger input electrical specifications
V134	2021-05-10	db	AM, FM, PM input electrical specifications
V135	2021-06-03	yg	Adding PE2, PE3, changing o/p power ranges
V136	2021-07-10	jk	Added max values for phase noise, spurious

AnaPico Inc. of Switzerland

Europa-Strasse 9
8152 Glattbrugg
Switzerland

Phone +41 44 440 00 50
Email sales@anapico.com

www.anapico.com
www.anapico.com/downloads/

